



Industriële connectoren



Industriële connectoren

4	Snelkeuzetabellen
10	plug2power-technologie
11	turn2fix-technologie
12	Stekkers
14	L-vormige stekkers
15	Wandapparaatstekkers
17	Aanbouwapparaatstekkers
20	Faseomvormers
21	Afsluitdeksels
22	Koppelingen
24	Wandcontactdozen
28	Combi-wandcontactdozen
29	Flensdozen recht
32	Flensdozen schuin
36	EventLine
38	Container-connectoren
39	Laagspanningsconnectoren
43	Technische kenmerken en gebruiksaanwijzing
45	Productnummer-index

1 Aansluittechniek zonder schroeven



- Tijdsbesparing bij de montage
- Plug2power-klem zonder schroeven
- Wordt geleverd met geopende contactklemmen
- Snelle en eenvoudige invoer van de kabel
- Sluiten en openen van de contactklem met slechts één vingerdruk
- Eenvoudige aansluiting door middel van kleurgecodeerde klemmen
- Slijtage- en onderhoudsvrije contacten

2 Snelle montage/demontage

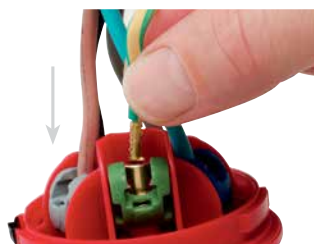

Montage:
Kabel insteken

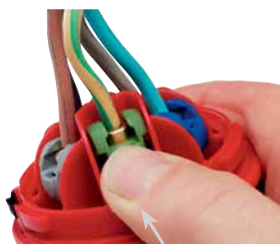

Klem sluiten

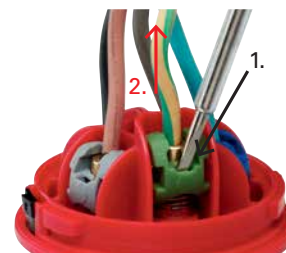

Demontage:
Klem met schroevendraaier openen, kabel eruit trekken

3 Geschikt voor alle kabeleinden

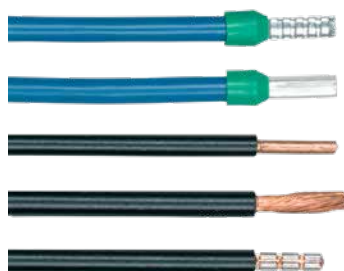

- Met of zonder adereindhuls
- Enkele, gestripte draden

4 Opname van alle kabeldiameters volgens de norm

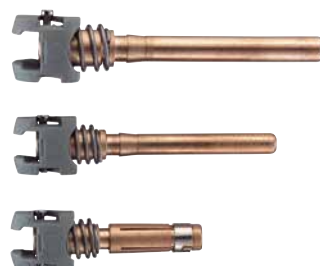

- 16 A: tot 2,5 mm² flexibel, tot 4 mm² met enkele draad
- 32 A: tot 6,0 mm² flexibel, tot 10 mm² met enkele draad
- Klemmen voor moeilijke omstandigheden
- Hoge treksterkte
- Schok- en trillingsbestendig

5 Gereedschapsloze montage



- Meervoudig sluitingssysteem
- Eenvoudige montage door middel van een draaivergrendeling van de aansluitbehuizing:
- 1. De marking "OPEN" van het bovenste en onderste deel tegenover elkaar brengen en het bovenste deel op het onderste deel steken
- 2. Het bovenste deel naar rechts draaien tot het vastklikt

6 Hoogwaardige aansluitklemmen



De contactdoosklemmen zijn ontworpen voor de volgende maximale kabeldiameters:

Nominale stroom	Kabeldiameter	
	flexibel mm ²	star (met één of meer draden) mm ²
16	4	6
32	6	10
63	16	25
125	50	70

7 Lamellenveer



- Gemakkelijk in te steken en uit te trekken
- Vermindering van de elektrische weerstand
- Zelfreinigend
- Optimaal contact; ten minste 10 contactpunten

Stekker

Volgens IEC 60309, EN 60309, VDE 0623

turn2fix



Stekker

spatwaterdicht IP44

- Schroefklemmen
- Snelsluitsysteem (turn2fix)
- Met onvernikkelde contacten

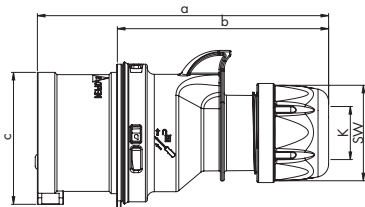

Aantal polen	3	4	5	3	4	5
Ampère	16			32		
a	122	128	134	150	150	155
b	86	92	98	104	104	109
c	47	53	61	63	63	70
K	6-15	6-15	8-16	11,5-20	11,5-20	11,5-22
SW	42	42	42	50	50	50
Gewicht g/stuk	109	128	151	181	201	232

Spanning	110 V~	230 V~	400 V~	440 V~	500 V~		
Frequentie	50/60 Hz	50/60 Hz	50/60 Hz	50/60 Hz	50/60 Hz		
Identificatie	4h	3p = 6h 4p/5p = 9h	3p = 9h 4p/5p = 6h	11h	7h		
Ampère	Polen	Prod. nr.	Prod. nr.	Prod. nr.	Prod. nr.	Prod. nr.	VPE
16	3	S31S10	S31S20			S31S50	10
16	4	S41S10	S41S20	S41S30	S41S40	S41S50	10
16	5		S51S20	S51S30		S51S50	10
32	3	S32S10	S32S20			S32S50	10
32	4	S42S10	S42S20	S42S30	S42S40	S42S50	10
32	5		S52S20	S52S30		S52S50	10

plug2power turn2fix



Stekker

spatwaterdicht IP44

- aansluittechniek zonder schroeven (plug2power)
- Snelsluitsysteem (turn2fix)
- Met vernikkelde contacten

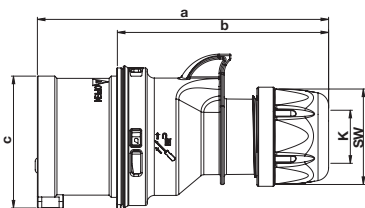

Aantal polen	3	4	5	3	4	5
Ampère	16			32		
a	122	128	134	150	150	155
b	86	92	98	104	104	109
c	47	53	61	63	63	70
K	6-15	6-15	8-16	11,5-20	11,5-20	11,5-22
SW	42	42	42	50	50	50
Gewicht g/stuk	111	132	156	186	206	241

Spanning	110 V~	230 V~	400 V~		
Frequentie	50/60 Hz	50/60 Hz	50/60 Hz		
Identificatie	4h	3p = 6h 4p/5p = 9h	3p = 9h 4p/5p = 6h		
Ampère	Polen	Prod. nr.	Prod. nr.	Prod. nr.	VPE
16	3	S31SL10	S31SL20		10
16	4	S41SL10	S41SL20	S41SL30	10
16	5		S51SL20	S51SL30	10
32	3	S32SL10	S32SL20		10
32	4	S42SL10	S42SL20	S42SL30	10
32	5		S52SL20	S52SL30	10

Stekker

Volgens IEC 60309, EN 60309, VDE 0623

turn2fix



Stekker

waterdicht IP67

- Schroefklemmen
- Snelsluitsysteem (turn2fix)
- Met vernikkelde contacten

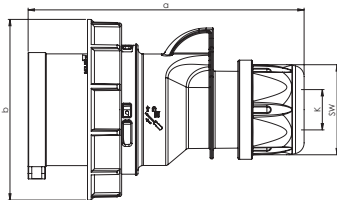

Aantal polen	3	4	5	3	4	5
Ampère	16			32		
a	122	128	134	150	150	155
b	71	79	87	93	93	100
K	6-15	6-15	8-16	11,5-20	11,5-20	11,5-22
SW	42	42	42	50	50	50
Gewicht g/stuk	130	154	183	223	242	276

Spanning		110 V~	230 V~	>50 V~	400 V~	440 V~	500 V~	
Frequentie		50/60 Hz	50/60 Hz	50/60 Hz	50/60 Hz	50/60 Hz	50/60 Hz	
Identificatie		4h	3p = 6h 4p/5p = 9h	1h	3p = 9h 4p/5p = 6h	11h	7h	
Ampère	Polen	Prod. nr.	Prod. nr.		Prod. nr.	Prod. nr.	Prod. nr.	VPE
16	3	S31S15	S31S25	S31S05			S31S55	10
16	4	S41S15	S41S25		S41S35	S41S45	S41S55	10
16	5		S51S25	S51S05	S51S35		S51S55	10
32	3	S32S15	S32S25	S32S05			S32S55	10
32	4	S42S15	S42S25		S42S35	S42S45	S42S55	10
32	5		S52S25	S52S05	S52S35		S52S55	10



Stekker

spatwaterdicht IP44

- HighPower-versie vernikkelde contacten met pilotcontact
- Schroefklemmen

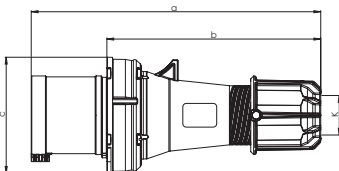

Aantal polen	3	4	5
Ampère	63		
a	257	257	257
b	190	190	190
c	102	102	102
SW	14,5-36	14,5-36	14,5-36
Gewicht g/stuk	530	572	621

Spanning		230 V~	400 V~	500 V~	
Frequentie		50/60 Hz	50/60 Hz	50/60 Hz	
Identificatie		3p = 6h 4p/5p = 9h	3p = 9h 4p/5p = 6h	7h	
Ampère	Polen	Prod. nr.	Prod. nr.	Prod. nr.	VPE
63	3	S33S20		S33S50	2
63	4	S43S20	S43S30	S43S50	2
63	5	S53S20	S53S30	S53S50	2

Stekker

volgens IEC 60309, EN 60309, VDE 0623



Stekker

waterdicht IP67

- HighPower-versie vernikkelde contacten met pilotcontact
- Schroefklemmen

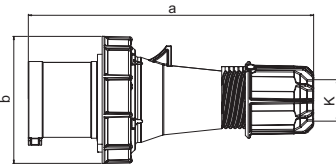

Aantal polen	3	4	5	3	4	5
Ampère	16			125		
a	257	257	257	270	270	270
b	114	114	114	131	131	131
K	14,5-36	14,5-36	14,5-36	22,5-50	22,5-50	22,5-50
Gewicht g/stuk	570	617	666	956	1064	1169

Spanning	230 V~	>50 V~	400 V~	440 V~	500 V~
Frequentie	50/60 Hz	50/60 Hz	50/60 Hz	50/60 Hz	50/60 Hz
Identificatie	3p = 6h 4p/5p = 9h	1h	3p = 9h 4p/5p = 6h	11h	7h

Ampère	Polen	Prod. nr.		Prod. nr.	Prod. nr.	Prod. nr.	VPE
63	3	S33S25				S33S55	2
63	4	S43S25		S43S35	S43S45	S43S55	2
63	5	S53S25	S53S05	S53S35		S53S55	2
125	3	S34S25				S34S55	2
125	4	S44S25		S44S35	S44S45	S44S55	2
125	5	S54S25	S54S05	S54S35		S54S55	2

L-vormige stekkers

volgens IEC 60309, EN 60309, VDE 0623

turn2fix



L-vormige stekkers

spatwaterdicht IP44

- Schroefklemmen
- Snelsluitstelsysteem (turn2fix)
- Met onvernikkelde contacten

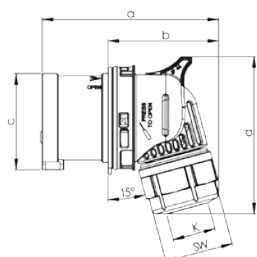

Aantal polen	3	5
Ampère	16	
a	96	108
b	59	71
c	47	61
e°	82	99
K	6-15	8 / 16
SW	38	42
Gewicht g/stuk	107	155

Spanning	230 V~	400 V~		
Frequentie	50/60 Hz	50/60 Hz		
Identificatie	3p = 6h 4p/5p = 9h	3p = 9h 4p/5p = 6h		
Ampère	Polen	Prod. nr.	Prod. nr.	VPE
16	3	S31S22		10
16	4		S51S32	10

Wandapparaatstekker

volgens IEC 60309, EN 60309, VDE 0623



Wandapparaatstekker

spatwaterdicht IP44

- Schroefklemmen
- Kabelinvoer aan boven- of achterkant
- inclusief doorvoertule
- Met onvernikkelde contacten

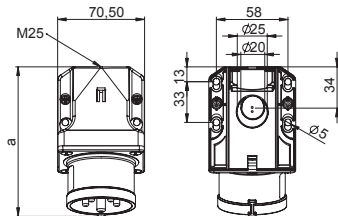

b = hoogte
Hoek = 15°

Aantal polen	3	4	5	3	4	5
Ampère	16			32		
a	120	121	122	131	131	132
b	76	76	79	82	82	85
Gewicht g/stuk	173	188	205	212	232	253

Spanning	110 V~	230 V~	400 V~	440 V~	500 V~		
Frequentie	50/60 Hz	50/60 Hz	50/60 Hz	50/60 Hz	50/60 Hz		
Identificatie	4h	3p = 6h 4p/5p = 9h	3p = 9h 4p/5p = 6h	11h	7h		
Ampère	Polen	Prod. nr.	Prod. nr.	Prod. nr.	Prod. nr.	Prod. nr.	VPE
16	3	G31S10	G31S20			G31S50	10
16	4	G41S10	G41S20	G41S30	G41S40	G41S50	10
16	5		G51S20	G51S30		G51S50	10
32	3	G32S10	G32S20			G32S50	10
32	4	G42S10	G42S20	G42S30	G42S40	G42S50	10
32	5		G52S20	G52S30		G52S50	10



Wandapparaatstekker

spatwaterdicht IP44

- Schroefklemmen
- doorslijpbaar
- Kabelinvoer boven, 2 x onder of achter
- inclusief doorvoertule
- Met onvernikkelde contacten

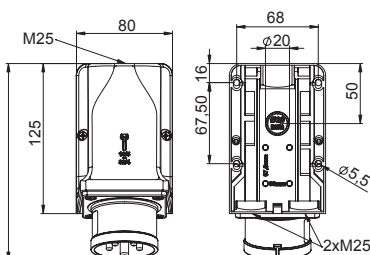

b = hoogte
Hoek = 15°

Aantal polen	3	4	5	3	4	5
Ampère	16			32		
a	163	163	164	173	173	174
b	109	109	112	115	115	118
M	3 x 25	3 x 25	3 x 25	3 x 25	3 x 25	3 x 25
Gewicht g/stuk	263	278	295	302	322	341

Spanning	230 V~	400 V~		
Frequentie	50/60 Hz	50/60 Hz		
Identificatie	3p = 6h 4p/5p = 9h	3p = 9h 4p/5p = 6h		
Ampère	Polen	Prod. nr.	Prod. nr.	VPE
16	3	G31S22		5
16	4	G41S22		5
16	5		G51S32	5
32	3	G32S22		5
32	4	G42S22		5
32	5		G52S32	5

Wandapparaatstekker

volgens IEC 60309, EN 60309, VDE 0623



Wandapparaatstekker

waterdicht IP67

- HighPower-uitvoering
- vernikkelde contacten met pilotcontact
- Schroefklemmen
- Kabelvoer boven, onder of achter
- Behuizing 180° draaibaar inclusief blinde schroefverbinding

Waterbeschermkap zie pagina 21

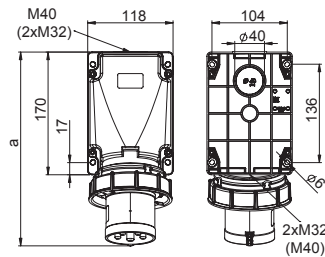

b = hoogte, hoek = 15°

Aantal polen	3	4	5
Ampère	63		
a	271	271	271
b	175	175	175
Gewicht g/stuk	812	864	914

Spanning		230 V~	400 V~	500 V~	
Frequentie		50/60 Hz	50/60 Hz	50/60 Hz	
Identificatie		3p = 6h 4p/5p = 9h	3p = 9h 4p/5p = 6h	7h	
Ampère	Polen	Prod. nr.	Prod. nr.	Prod. nr.	VPE
63	3	G33S25		G33S55	2
63	4	G43S25	G43S35	G43S55	2
63	5	G53S25	G53S35	G53S55	2



Wandapparaatstekker

waterdicht IP67

- HighPower-uitvoering
- vernikkelde contacten met pilotcontact
- Schroefklemmen
- Kabelvoer boven, onder of achter
- Behuizing 180° draaibaar inclusief blinde schroefverbinding

Waterbeschermkap zie pagina 21

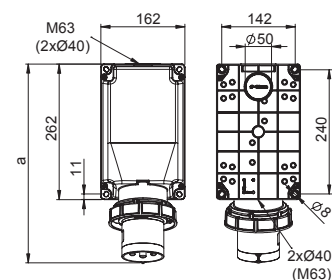

b = hoogte, hoek = 15°

Aantal polen	3	4	5
Ampère	125		
a	387	387	387
b	209	209	209
Gewicht g/stuk	1620	1725	1834

Spanning		230 V~	400 V~	500 V~	
Frequentie		50/60 Hz	50/60 Hz	50/60 Hz	
Identificatie		3p = 6h 4p/5p = 9h	3p = 9h 4p/5p = 6h	7h	
Ampère	Polen	Prod. nr.	Prod. nr.	Prod. nr.	VPE
125	3	G34S25		G34S55	1
125	4	G44S25	G44S35	G44S55	1
125	5	G54S25	G54S35	G54S55	1

Aanbouwapparaatstekker

volgens IEC 60309, EN 60309, VDE 0623



Aanbouwapparaatstekker recht

spatwaterdicht IP44

- Schroefklemmen
- Aanwijzing volgens EN 60309: Voor correct gebruik moet een borglip of borggroef worden aangebracht.
- Met onvernikkelde contacten

a met flens 75 x 75 mm,
b met flens 70 x 70 mm

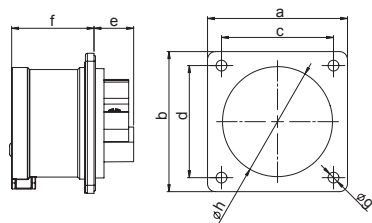

Aantal polen	5a	5a	3b	4b	5b	3b	4b	5b
Ampère	16	32	16			32		
a en b	75	75	70	70	70	70	70	70
c en d	60	60	56	56	56	56	56	56
e	20	21	21	21	20	21	21	21
f	42	51	42	42	42	51	51	51
g	5,5	5,5	5,5	5,5	5,5	5,5	5,5	5,5
h	55	55	43	43	55	55	55	55
Gewicht [g/stuk]	121	170	86	101	118	125	145	165

Spanning		110 V~	230 V~	400 V~	500 V~	
Frequentie		50/60 Hz	50/60 Hz	50/60 Hz	50/60 Hz	
Identificatie		4h	3p = 6h 4p/5p = 9h	3p = 9h 4p/5p = 6h	7h	
Ampère	Polen	Prod. nr.	Prod. nr.	Prod. nr.	Prod. nr.	VPE
16	5a			A51S34		10
32	5a			A52S34		10
16	3b	A31S12	A31S22		A31S52	10
16	4b	A41S12	A41S22	A41S32	A41S52	10
16	5b		A51S22	A51S32	A51S52	10
32	3b	A32S12	A32S22		A32S52	10
32	4b	A42S12	A42S22	A42S32	A42S52	10
32	5b		A52S22	A52S32	A52S52	10



Aanbouwapparaatstekker recht

spatwaterdicht IP44

- Schroefklemmen
- Aanwijzing volgens EN 60309: Voor correct gebruik moet een borglip of borggroef worden aangebracht.
- Met onvernikkelde contacten
- Met flens 60 x 60 mm

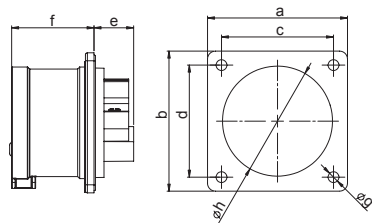

Aantal polen	3
Ampère	16
a en b	60
c en d	50
e	21
f	42
g	4,5
h	43
Gewicht g/stuk	78

Spanning		230 V~	
Frequentie		50/60 Hz	
Identificatie		3p = 6h 4p/5p = 9h	
Ampère	Polen	Prod. nr.	VPE
16	3	A31S23	10

Aanbouwapparaatstekker

volgens IEC 60309, EN 60309, VDE 0623

turn2fix



L-vormige aanbouw-apparaatstekker

spatwaterdicht IP44

- Schroefklemmen
- Snelsluitsysteem (turn2fix)
- Met onvernikkelde contacten

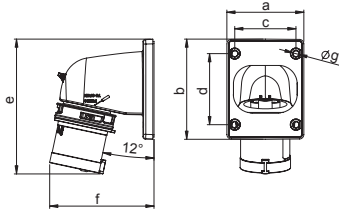

Aantal polen	3	4	5	3	4	5
Ampère	16			32		
a	66	66	90	90	90	90
b	86	86	100	100	100	100
c	53	53	77	77	77	77
d	61	61	85	85	85	85
e	116	117	153	163	163	164
f	90	93	98	100	100	103
g	5	5	5	5	5	5
Gewicht g/stuk	126	144	190	200	220	247

Spanning	110 V~	230 V~	400 V~	500 V~
Frequentie	50/60 Hz	50/60 Hz	50/60 Hz	50/60 Hz
Identificatie	4h	3p = 6h 4p/5p = 9h	3p = 9h 4p/5p = 6h	7h

Ampère	Polen	Prod. nr.	Prod. nr.	Prod. nr.	Prod. nr.	VPE
16	3	A31S11	A31S21		A31S51	10
16	4	A41S11	A41S21	A41S31	A41S51	10
16	5		A51S21	A51S31	A51S51	10
32	3	A32S11	A32S21		A32S51	10
32	4	A42S11	A42S21	A42S31	A42S51	10
32	5		A52S21	A52S31	A52S51	10

turn2fix



L-vormige aanbouw-apparaatstekker

waterdicht IP67

- Schroefklemmen
- Snelsluitsysteem (turn2fix)
- Met onvernikkelde contacten

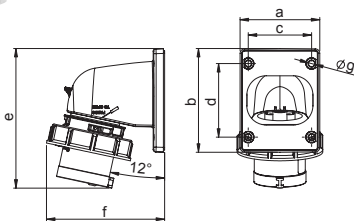

Aantal polen	3	4	5	3	4	5
Ampère	16			32		
a	66	66	90	90	90	90
b	86	86	100	100	100	100
c	53	53	77	77	77	77
d	61	61	85	85	85	85
e	116	117	153	163	163	164
f	99	103	107	110	110	114
g	5	5	5	5	5	5
Gewicht g/stuk	146	168	219	240	260	291

Spanning	110 V~	230 V~	400 V~	500 V~
Frequentie	50/60 Hz	50/60 Hz	50/60 Hz	50/60 Hz
Identificatie	4h	3p = 6h 4p/5p = 9h	3p = 9h 4p/5p = 6h	7h

Ampère	Polen	Prod. nr.	Prod. nr.	Prod. nr.	Prod. nr.	VPE
16	3	A31S16	A31S26		A31S56	10
16	4	A41S16	A41S26	A41S36	A41S56	10
16	5		A51S26	A51S36	A51S56	10
32	3	A32S16	A32S26		A32S56	10
32	4	A42S16	A42S26	A42S36	A42S56	10
32	5		A52S26	A52S36	A52S56	10

Aanbouwapparaatstekker

volgens IEC 60309, EN 60309, VDE 0623



Aanbouwapparaatstekker recht

waterdicht IP67

- HighPower-uitvoering
- vernikkelde contacten met pilootcontact
- Schroefklemmen
- Waterbeschermkap zie pagina 21

IP44 op aanvraag

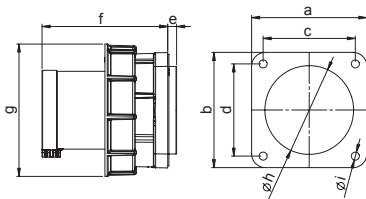

Aantal polen	3	4	5	3	4	5
Ampère	63			125		
axb	100	100	100	120	120	120
cxb	80	80	80	100	100	100
e	8	8	8	13	13	13
f	109	109	109	118	118	118
g	115	115	115	131	131	131
h	77	77	77	95	95	95
i	7	7	7	7	7	7
Gewicht g/stuk	479	531	570	786	891	998

Spanning		230 V~	400 V~	500 V~	
Frequentie		50/60 Hz	50/60 Hz	50/60 Hz	
Identificatie		3p = 6h 4p/5p = 9h	3p = 9h 4p/5p = 6h	7h	
Ampère	Polen	Prod. nr.	Prod. nr.	Prod. nr.	VPE
63	3	A33S27		A33S57	2
63	4	A43S27	A43S37	A43S57	2
63	5	A53S27	A53S37	A53S57	2
125	3	A34S27		A34S57	2
125	4	A44S27	A44S37	A44S57	2
125	5	A54S27	A54S37	A54S57	2

Faseomvormers

volgens IEC 60309, EN 60309, VDE 0623



Faseomvormers

spatwaterdicht IP44

- Schroefklemmen
- Snelsluitsysteem (turn2fix)
- Met onvernikkelde contacten

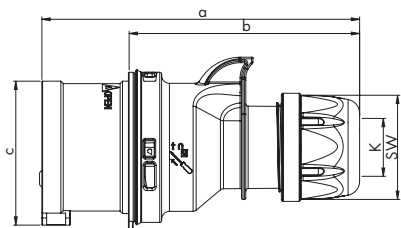

Aantal polen	5	5
Ampère	16	32
a	134	155
b	98	109
c	61	70
K	8-16	11,5-22
SW	42	50
Gewicht g/stuk	154	236

Spanning	400 V~		
Frequentie	50/60 Hz		
Identificatie	3p = 9h 4p/5p = 6h		
Ampère	Polen	Prod. nr.	VPE
16	5	S51S30P	10
32	5	S52S30P	10



Faseomvormer - wandapparaatstekker

spatwaterdicht IP44

- Schroefklemmen
- Kabelinvoer aan boven- of achterkant
- Met onvernikkelde contacten

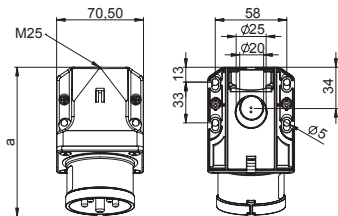

b = hoogte
Hoek = 15°

Aantal polen	5	5
Ampère	16	32
a	122	132
b	79	85
M	25	25
Gewicht g/stuk	205	255

Spanning	400 V~		
Frequentie	50/60 Hz		
Identificatie	3p = 9h 4p/5p = 6h		
Ampère	Polen	Prod. nr.	VPE
16	5	G51S30P	10
32	5	G52S30P	10

Afsluitdeksel

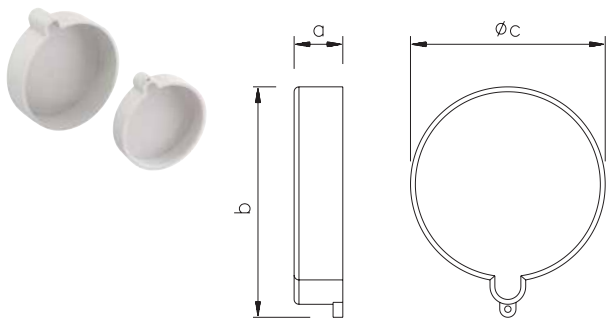

Aantal polen	3	4	5	3	4	5
Ampère	16			32		
a	15	15	15	15	15	15
b	56	63	71	71	71	79
c	48	54	61	61	61	67
Gewicht g/stuk	10	12	14	14	14	16
Prod. nr.	VD0163	VD0164	VD0165	VD0323	VD0323	VD0325

Stofkap 16 en 32 A

- voor alle stekkers en apparaatstekkers
- bescherming van de contacten tegen verontreiniging

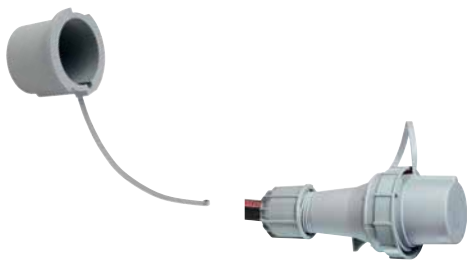

Aantal polen	3	4	5	3	4	5
Ampère	63			125		
a	72	72	72	82	82	82
b	78	78	78	91	91	91
c	211	211	211	205	205	205
d	4	4	4	5	5	5
Gewicht g/stuk	75	75	75	98	98	98
Prod. nr.	WS0633	WS0633	WS0633	WS1253	WS1253	WS1253

Waterbeschermkap 63 en 125 A

- waterdicht IP67
- voor alle 63 en 125 A stekkers en apparaatstekkers



Koppelingen

volgens IEC 60309, EN 60309, VDE 0623

turn2fix



Koppeling

spatwaterdicht IP44

- Klapdeksel met duimgreep
- Schroefklemmen
- Snelsluitsysteem (turn2fix)
- Met onvernikkelde contacten

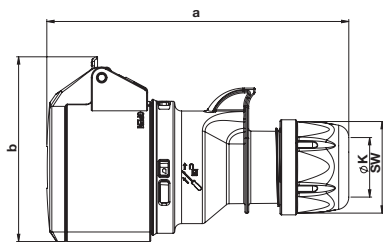

Aantal polen	3	4	5	3	4	5
Ampère	16			32		
a	133	138	145	161	161	168
b	74	82	89	94	94	99
K	6-15	6-15	8-16	11,5-20	11,5-20	11,5-22
SW	42	42	42	50	50	50
Gewicht g/stuk	134	161	188	228	244	270

Spanning		110 V~	230 V~	400 V~	440 V~	500 V~	
Frequentie		50/60 Hz	50/60 Hz	50/60 Hz	50/60 Hz	50/60 Hz	
Identificatie		4h	3p = 6h 4p/5p = 9h	3p = 9h 4p/5p = 6h	11h	7h	
Ampère	Polen	Prod. nr.	Prod. nr.	Prod. nr.	Prod. nr.	Prod. nr.	VPE
16	3	K31S10	K31S20			K31S50	10
16	4	K41S10	K41S20	K41S30	K41S40	K41S50	10
16	5		K51S20	K51S30		K51S50	10
32	3	K32S10	K32S20			K32S50	10
32	4	K42S10	K42S20	K42S30	K42S40	K42S50	10
32	5		K52S20	K52S30		K52S50	10

plug2power turn2fix



Koppeling

spatwaterdicht IP44

- Klapdeksel met duimgreep
- aansluittechniek zonder schroeven (plug2power)
- Snelsluitsysteem (turn2fix)
- Met vernikkelde contacten

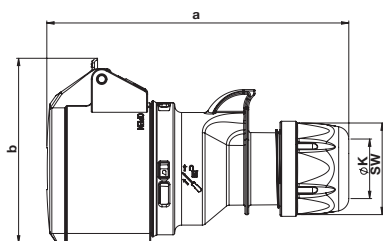

Aantal polen	3	4	5	3	4	5
Ampère	16			32		
a	133	138	145	161	161	168
b	74	82	89	94	94	99
K	6-15	6-15	8-16	11,5-20	11,5-20	11,5-22
SW	42	42	42	50	50	50
Gewicht g/stuk	136	161	193	228	243	271

Spanning		110 V~	230 V~	400 V~	
Frequentie		50/60 Hz	50/60 Hz	50/60 Hz	
Identificatie		4h	3p = 6h 4p/5p = 9h	3p = 9h 4p/5p = 6h	
Ampère	Polen	Prod. nr.	Prod. nr.	Prod. nr.	VPE
16	3	K31SL10	K31SL20		10
16	4	K41SL10	K41SL20	K41SL30	10
16	5		K51SL20	K51SL30	10
32	3	K32SL10	K32SL20		10
32	4	K42SL10	K42SL20	K42SL30	10
32	5		K52SL20	K52SL30	10

Koppelingen

volgens IEC 60309, EN 60309, VDE 0623

turn2fix



Koppeling

waterdicht IP67

- Schroefklemmen
- Snelsluitsysteem (turn2fix)
- Met vernikkelde contacten

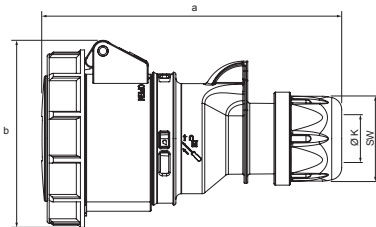

Aantal polen	3	4	5	3	4	5
Ampère	16			32		
a	133	139	147	163	163	171
b	78	84	92	96	96	102
K	6-15	6-15	8-16	11,5-20	11,5-20	11,5-22
SW	42	42	42	50	50	50
Gewicht g/stuk	155	186	227	275	292	338

Spanning		110 V~	230 V~	>50 V~	400 V~	440 V~	500 V~		
Frequentie		50/60 Hz	50/60 Hz	50/60 Hz	50/60 Hz	50/60 Hz	50/60 Hz		
Identificatie		4h	3p = 6h 4p/5p = 9h	1h	3p = 9h 4p/5p = 6h	11h	7h		
Ampère	Polen	Prod. nr.	Prod. nr.	Prod. nr.	Prod. nr.	Prod. nr.	Prod. nr.	VPE	
16	3	K31S15	K31S25	K31S05			K31S55	10	
16	4	K41S15	K41S25		K41S35	K41S45	K41S55	10	
16	5		K51S25	K51S05	K51S35		K51S55	10	
32	3	K32S15	K32S25	K32S05			K32S55	10	
32	4	K42S15	K42S25		K42S35	K42S45	K42S55	10	
32	5		K52S25	K52S05	K52S35		K52S55	10	



Koppeling

spatwaterdicht IP44

- HighPower-uitvoering
- Schroefklemmen
- met pilotcontact
- Contacten: Messing met CuBe lamellencontact

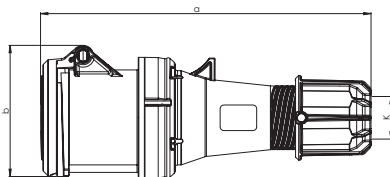

Aantal polen	3	4	5
Ampère	63		
a	269	269	269
b	107	107	107
K	14,5-36	14,5-36	14,5-36
Gewicht g/stuk	624	664	720

Spanning		230 V~	400 V~	500 V~		
Frequentie		50/60 Hz	50/60 Hz	50/60 Hz		
Identificatie		3p = 6h 4p/5p = 9h	3p = 9h 4p/5p = 6h	7h		
Ampère	Polen	Prod. nr.	Prod. nr.	Prod. nr.	VPE	
63	3	K33S20		K33S50	2	
63	4	K43S20	K43S30	K43S50	2	
63	5	K53S20	K53S30	K53S50	2	

Koppelingen

volgens IEC 60309, EN 60309, VDE 0623



Koppeling

waterdicht IP67

- HighPower-uitvoering
- met pilotcontact
- Schroefklemmen
- Contacten: Messing met CuBe lamellencontact

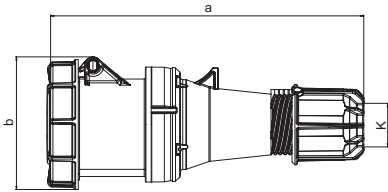

Aantal polen	3	4	5	3	4	5
Ampère	63			125		
a	269	269	269	287	287	287
b	114	114	114	124	124	124
K	14,5-36	14,5-36	14,5-36	22,5-50	22,5-50	22,5-50
Gewicht g/stuk	669	710	768	1060	1167	1266

Spanning	230 V~	>50 V~	400 V~	440 V~	500 V~		
Frequentie	50/60 Hz	50/60 Hz	50/60 Hz	50/60 Hz	50/60 Hz		
Identificatie	3p = 6h 4p/5p = 9h	1h	3p = 9h 4p/5p = 6h	11h	7h		
Ampère	Polen	Prod. nr.	Prod. nr.	Prod. nr.	Prod. nr.	Prod. nr.	VPE
63	3	K33S25				K33S55	2
63	4	K43S25		K43S35	K43S45	K43S55	2
63	5	K53S25	K53S05	K53S35		K53S55	2
125	3	K34S25				K34S55	2
125	4	K44S25		K44S35	K44S45	K44S55	2
125	5	K54S25	K54S05	K54S35		K54S55	2

Wandcontactdozen

volgens IEC 60309, EN 60309, VDE 0623



Wandcontactdoos

spatwaterdicht IP44

- aansluittechniek zonder schroeven (plug2power)
- Kabelinvoer aan boven- of achterkant
- inclusief doorvoertule
- Met vernikkelde contacten

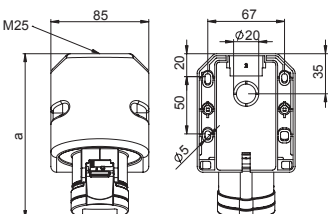

Aantal polen	3	4	5	3	4	5
Ampère	16			32		
a	142	145	144	155	155	157
b	97	98	104	106	106	111
M	25	25	25	25	25	25
Gewicht g/stuk	228	240	264	274	290	319

b = hoogte, hoek = 15°

Spanning	110 V~	230 V~	400 V~		
Frequentie	50/60 Hz	50/60 Hz	50/60 Hz		
Identificatie	4h	3p = 6h 4p/5p = 9h	3p = 9h 4p/5p = 6h		
Ampère	Polen	Prod. nr.	Prod. nr.	Prod. nr.	VPE
16	3	D31SL10	D31SL20		10
16	4	D41SL10	D41SL20	D41SL30	10
16	5		D51SL20	D51SL30	10
32	3	D32SL10	D32SL20		10
32	4	D42SL10	D42SL20	D42SL30	10
32	5		D52SL20	D52SL30	10

Wandcontactdozen

volgens IEC 60309, EN 60309, VDE 0623



Wandcontactdoos

spatwaterdicht IP44

- Schroefklemmen
- Kabelinvoer aan boven- of achterkant
- inclusief doorvoertule
- Met onvernikkelde contacten

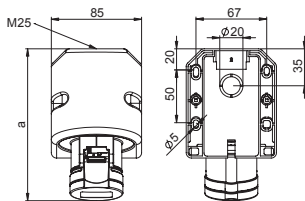

Aantal polen	3	4	5	3	4	5
Ampère	16			32		
a	142	145	144	155	155	157
b	97	98	104	106	106	111
M	25	25	25	25	25	25
Gewicht g/stuk	226	240	259	274	291	318

b = hoogte, hoek = 15°

Spanning		110 V~	230 V~	400 V~	500 V~	
Frequentie		50/60 Hz	50/60 Hz	50/60 Hz	50/60 Hz	
Identificatie		4h	3p = 6h 4p/5p = 9h	3p = 9h 4p/5p = 6h	7h	
Ampère	Polen	Prod. nr.	Prod. nr.	Prod. nr.	Prod. nr.	VPE
16	3	D31S11	D31S21		D31S51	10
16	4	D41S11	D41S21	D41S31	D41S51	10
16	5		D51S21	D51S31	D51S51	10
32	3	D32S11	D32S21		D32S51	10
32	4	D42S11	D42S21	D42S31	D42S51	10
32	5		D52S21	D52S31	D52S51	10



Wandcontactdoos

spatwaterdicht IP44

- Schroefklemmen
- doorslijpbaar
- Kabelinvoer
- boven, 2 x onder of achter
- inclusief doorvoertule
- Met onvernikkelde contacten

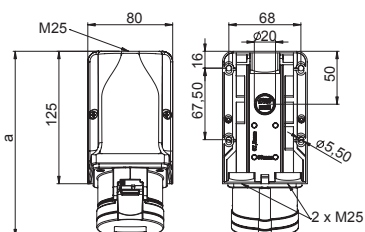

Aantal polen	3	4	5	3	4	5
Ampère	16			32		
a	142	145	144	155	155	157
b	97	98	104	106	106	111
M	25	25	25	25	25	25
Gewicht g/stuk	226	240	259	274	291	318

b = hoogte, hoek = 15°

Spanning		230 V~	400 V~	
Frequentie		50/60 Hz	50/60 Hz	
Identificatie		3p = 6h 4p/5p = 9h	3p = 9h 4p/5p = 6h	
Ampère	Polen	Prod. nr.	Prod. nr.	VPE
16	3	D31S22		5
16	4	D41S22	D41S32	5
16	5	D51S22	D51S32	5
32	3	D32S22		5
32	4	D42S22	D42S32	5
32	5	D52S22	D52S32	5

Wandcontactdozen

volgens IEC 60309, EN 60309, VDE 0623



Wandcontactdoos

watervdicht IP67

- Schroefklemmen
- Kabelinvoer boven of achter
- incl. blinde schroefverbinding
- Met vernikkelde contacten

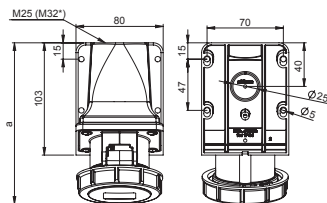

Aantal polen	3	4	5	3	4	5
Ampère	16			32		
a	146	148	148	161	161	163
b	96	99	102	108	108	112
K	25	25	25	25	25	25
Gewicht g/stuk	226	241	275	298	314	351

b = hoogte, hoek = 15°

Spanning	110 V~	230 V~	400 V~	440 V~	500 V~		
Frequentie	50/60 Hz	50/60 Hz	50/60 Hz	50/60 Hz	50/60 Hz		
Identificatie	4h	3p = 6h 4p/5p = 9h	3p = 9h 4p/5p = 6h	11h	7h		
Ampère	Polen	Prod. nr.	Prod. nr.	Prod. nr.	Prod. nr.	Prod. nr.	VPE
16	3	D31S15	D31S25			D31S55	5
16	4	D41S15	D41S25	D41S35	D41S45	D41S55	5
16	5		D51S25	D51S35		D51S55	5
32	3	D32S15	D32S25			D32S55	5
32	4	D42S15	D42S25	D42S35	D42S45	D42S55	5
32	5		D52S25	D52S35		D52S55	5

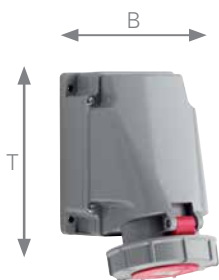

Wandcontactdoos

watervdicht IP67

Basisbehuizing b x h x d =
118 x 173 x 170 mm
1 x M40 boven, 2 x M32 onder

- HighPower-uitvoering
- met pilotcontact
- Schroefklemmen
- Kabelinvoer boven, onder of achter
- Behuizing 180° draaibaar
- Contacten: Messing met CuBe lamellenkontakt
- incl. blinde schroefverbinding

spatwaterdicht IP44
op aanvraag

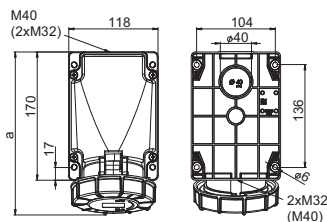

Aantal polen	3	4	5
Ampère	63		
a	213	213	213
b	173	173	173
Gewicht g/stuk	820	869	923

b = hoogte, hoek = 15°

Spanning	230 V~	400 V~	440 V~	500 V~		
Frequentie	50/60 Hz	50/60 Hz	50/60 Hz	50/60 Hz		
Identificatie	3p = 6h 4p/5p = 9h	3p = 9h 4p/5p = 6h	11h	7h		
Ampère	Polen	Prod. nr.	Prod. nr.	Prod. nr.	Prod. nr.	VPE
63	3	D33S26			D33S56	5
63	4	D43S26	D43S36	D43S46	D43S56	5
63	5	D53S26	D53S36		D53S56	5

Wandcontactdozen

volgens IEC 60309, EN 60309, VDE 0623



Wandcontactdoos

watervdicht IP67
Basisbehuizing b x h x d =
162 x 195 x 262 mm
1 x M40 boven, 2 x Ø40 onder

- HighPower-uitvoering
- met pilootcontact
- Schroefklemmen
- Kabelinvoer boven, onder of achter
- Behuizing 180° draaibaar
- Contacten: Messing met CuBe lamellenkontakt
- incl. blinde schroefverbinding

spatwaterdicht IP44
op aanvraag

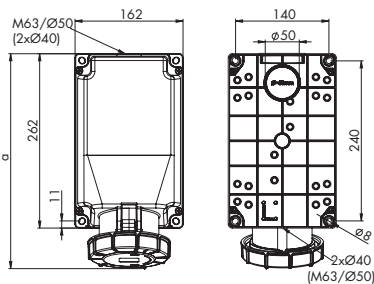

Aantal polen	3	4	5
Ampère	63		
a	306	306	306
b	195	195	195
Gewicht g/stuk	1360	1409	1463

b = hoogte, hoek = 15°

Spanning		400 V~	
Frequentie		50/60 Hz	
Identificatie		3p = 9h 4p/5p = 6h	
Ampère	Polen	Prod. nr.	VPE
63	3		
63	4	D43S37	2
63	5	D53S37	2

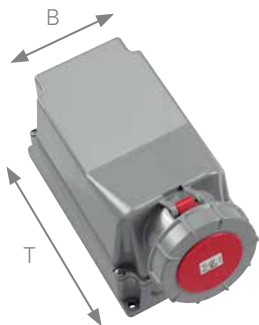

Wandcontactdoos

watervdicht IP67
* Basisbehuizing b x h x d =
162 x 205 x 262 mm
1 x Ø50 boven, 2 x Ø40 onder

**Basisbehuizing b x h x d =
162 x 205 x 262 mm
1 x M63 boven, 2 x Ø40 onder

- HighPower-uitvoering
- met pilootcontact
- Schroefklemmen
- Kabelinvoer boven, onder of achter
- Behuizing 180° draaibaar
- Contacten: Messing met CuBe lamellenkontakt
- incl. blinde schroefverbinding

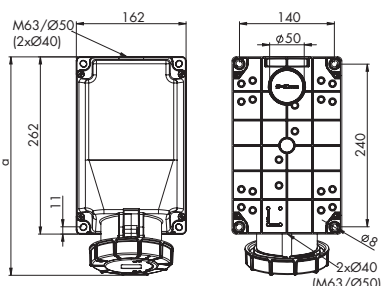

Aantal polen	3	4	5
Ampère	125		
a	322	322	322
b	205	205	205
Gewicht g/stuk	1745	1752	1852

b = hoogte, hoek = 15°

Spanning		230 V~	400 V~	440 V~	500 V~	
Frequentie		50/60 Hz	50/60 Hz	50/60 Hz	50/60 Hz	
Identificatie		3p = 6h 4p/5p = 9h	3p = 9h 4p/5p = 6h	11h	7h	
Ampère	Polen	Prod. nr.	Prod. nr.	Prod. nr.	Prod. nr.	VPE
125*	3	D34S27			D34S57	5
125**	4	D44S27	D44S37	D44S47	D44S57	5
125***	5	D54S27	D54S37		D54S57	5

Combi-wandcontactdozen

volgens IEC 60309, EN 60309, VDE 0623



Combi-wandcontactdoos

spatwaterdicht IP44

- Wanddoos met geïntegreerde SCHUKO contactdoos
- Aansluitklemmen tot 10 mm²
- volledig bedraad
- Kabelinvoer boven, 2x onder of achter
- bij 32 A: SCHUKO contactdoos beveiligd, zekering (10 A traag)
- inclusief doorvoertule
- Met onvernikkelde contacten

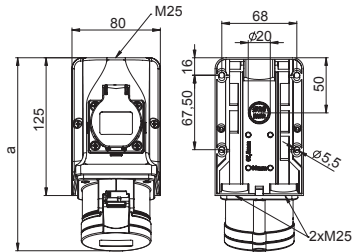

Aantal polen	4	5	3	5
Ampère	16		32	
a	176	176	188	188
b	130	133	136	141
M	3x25	3x25	3x25	3x25
Gewicht g/stuk	405	424	470	481

b = hoogte, hoek = 15°

Spanning	400 V~		
Frequentie	50/60 Hz		
Identificatie	3p = 9h 4p/5p = 6h		
Ampère	Polen	Prod. nr.	VPE
16	4	D41S331	5
16	5	D51S331	5
32	4	D42S331	5
32	5	D52S331	5

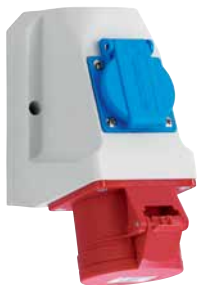

Combi-wandcontactdoos

spatwaterdicht IP44

- Wanddoos met geïntegreerde veiligheidscontactdoos met penaarnding (met Frans/Belgische aarde)
- Aansluitklemmen tot 10 mm²
- volledig bedraad
- Kabelinvoer boven, 2x onder of achter
- bij 32 A: Veiligheidscontactdoos beveiligd, zekering (10 A traag)
- inclusief doorvoertule
- Met onvernikkelde contacten

Spanning	400 V~		
Frequentie	50/60 Hz		
Identificatie	3p = 9h 4p/5p = 6h		
Ampère	Polen	Prod. nr.	VPE
16	4	D41S333	5
16	5	D51S333	5
32	4	D42S333	5
32	5	D52S333	5

Flenscontactdozen recht

volgens IEC 60309, EN 60309, VDE 0623



Flenscontactdoos recht

spatwaterdicht IP54
*spatwaterdicht IP44

- Schroefklemmen
- geschikt voor kabelkanalen
- Met onvernikkelde contacten

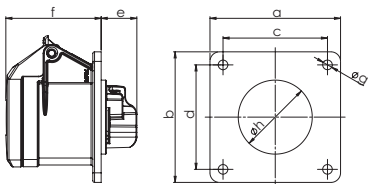

Aantal polen	3	4	5	3	4	5
Ampère	16			32		
a en b	75	75	75	75	75	75
c en d	60	60	60	60	60	60
e	21	21	21	23	23	23
f	55	55	55	67	67	67
g	5,5	5,5	5,5	5,5	5,5	5,5
h	43	45	55	55	55	58
Gewicht g/stuk	120	132	150	167	182	210

Spanning		110 V~	230 V~	400 V~	440 V~	500 V~	
Frequentie		50/60 Hz	50/60 Hz	50/60 Hz	50/60 Hz	50/60 Hz	
Identificatie		4h	3p = 6h 4p/5p = 9h	3p = 9h 4p/5p = 6h	11h	7h	
Ampère	Polen	Prod. nr.	Prod. nr.	Prod. nr.	Prod. nr.	Prod. nr.	VPE
16	3	F31S100	F31S200			F31S500	10
16*	4	F41S100	F41S200	F41S300	F41S400	F41S500	10
16	5		F51S200	F51S300		F51S500	10
32*	3	F32S100	F32S200			F32S500	10
32*	4	F42S100	F42S200	F42S300	F42S400	F42S500	10
32	5		F52S200	F52S300		F52S500	10

plug  power



Flenscontactdoos recht

spatwaterdicht IP54
*spatwaterdicht IP44

- aansluittechniek zonder schroeven (plug2power)
- geschikt voor kabelkanalen
- Met vernikkelde contacten

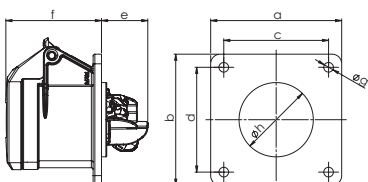

Aantal polen	3	4	5	3	4	5
Ampère	16			32		
a en b	75	75	75	75	75	75
c en d	60	60	60	60	60	60
e	27	27	27	27	27	27
f	55	55	55	67	67	67
g	5,5	5,5	5,5	5,5	5,5	5,5
h	43	45	55	55	55	58
Gewicht g/stuk	123	132	155	167	182	211

Spanning		110 V~	230 V~	400 V~	
Frequentie		50/60 Hz	50/60 Hz	50/60 Hz	
Identificatie		4h	3p = 6h 4p/5p = 9h	3p = 9h 4p/5p = 6h	
Ampère	Polen	Prod. nr.	Prod. nr.	Prod. nr.	VPE
16	3	F31SL11	F31SL21		10
16*	4	F41SL11	F41SL21	F41SL31	10
16	5		F51SL21	F51SL31	10
32*	3	F32SL11	F32SL21		10
32*	4	F42SL11	F42SL21	F42SL31	10
32	5		F52SL21	F52SL31	10

Flenscontactdozen recht

volgens IEC 60309, EN 60309, VDE 0623



Flenscontactdoos recht

spatwaterdicht IP54
*spatwaterdicht IP44

- Schroefklemmen
- Met onvernikkelde contacten

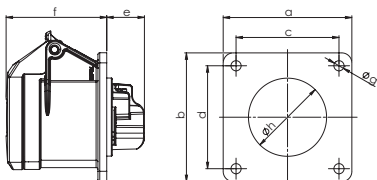

Aantal polen	3	4	5	3	4	5
Ampère	16			32		
a en b	70	70	70	70	70	70
c en d	56	56	56	56	56	56
e	21	21	21	23	23	23
f	55	55	55	67	67	67
g	5,5	5,5	5,5	5,5	5,5	5,5
h	43	45	55	55	55	58
Gewicht g/stuk	115	127	141	162	178	206

Spanning		230 V~	400 V~	
Frequentie		50/60 Hz	50/60 Hz	
Identificatie		3p = 6h 4p/5p = 9h	3p = 9h 4p/5p = 6h	
Ampère	Polen	Prod. nr.	Prod. nr.	VPE
16	3	F31S201		10
16*	4	F41S201	F41S301	10
16	5	F51S201	F51S301	10
32*	3	F32S201		10
32*	4	F42S201	F42S301	10
32	5	F52S201	F52S301	10

plug  power



Flenscontactdoos recht

spatwaterdicht IP54

- Schroefklemmen
- Met onvernikkelde contacten

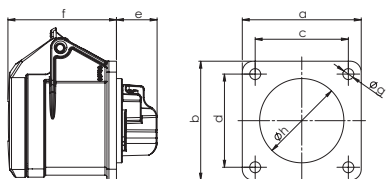

Aantal polen	3	3a
Ampère	16	
a en b	60	55
c en d	47	44
e	21	28
f	55	46
g	5,5	4,5
h	43	43
Gewicht g/stuk	105	120

Spanning		110 V~	230 V~	
Frequentie		50/60 Hz	50/60 Hz	
Identificatie		4h	3p = 6h 4p/5p = 9h	
Ampère	Polen	Prod. nr.	Prod. nr.	VPE
16	3	F31S102	F31S202	10
16a	4		F31S203	10

A met flens 55 x 55 mm

Flenscontactdozen recht

volgens IEC 60309, EN 60309, VDE 0623



Flenscontactdoos recht

watervdicht IP67

- Schroefklemmen
- Met vernikkelde contacten

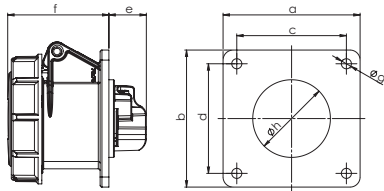

Aantal polen	3	4	5	3	4	5
Ampère	16			32		
a en b	75	75	75	75	75	75
c en d	60	60	60	60	60	60
e	21	21	21	23	23	23
f	56	57	59	69	69	71
g	5,5	5,5	5,5	5,5	5,5	5,5
h	43	45	55	55	55	58
Gewicht g/stuk	135	153	183	206	222	260



Flenscontactdoos recht

watervdicht IP67

- HighPower-uitvoering
- met pilotcontact
- Schroefklemmen
- Contacten: Messing met CuBe lamellencontact

spatwaterdicht IP44
op aanvraag met flens 100 x 100 mm

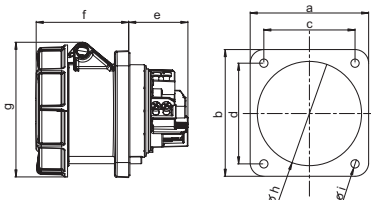

Spanning		110 V~	230 V~	>50 V~	400 V~	440 V~	500 V~	
Frequentie		50/60 Hz	50/60 Hz	50/60 Hz	50/60 Hz	50/60 Hz	50/60 Hz	
Identificatie		4h	3p = 6h 4p/5p = 9h	1h	3p = 9h 4p/5p = 6h	11h	7h	
Ampère	Polen	Prod. nr.	Prod. nr.	Prod. nr.	Prod. nr.	Prod. nr.	Prod. nr.	VPE
16	3	F31S150	F31S250	F31S050			F31S550	10
16	4	F41S150	F41S250		F41S350	F41S450	F41S550	10
16	5		F51S250	F51S050	F51S350		F51S550	10
32	3	F32S150	F32S250	F32S050			F32S550	10
32	4	F42S150	F42S250		F42S350	F42S450	F42S550	10
32	5		F52S250	F52S050	F52S350		F52S550	10

Aantal polen	3	4	5
Ampère	63		
Flens a	100	100	100
Flens b	100	100	100
Gatenafstand c	80	80	80
Gatenafstand d	80	80	80
e	50	50	50
f	80	80	80
g	114	114	114
h	85	85	85
i	7	7	7
Gewicht g/stuk	440	485	539

Spanning		230 V~	>50 V~	400 V~	440 V~	500 V~	
Frequentie		50/60 Hz	50/60 Hz	50/60 Hz	50/60 Hz	50/60 Hz	
Identificatie		3p = 6h 4p/5p = 9h	1h	3p = 9h 4p/5p = 6h	11h	7h	
Ampère	Polen	Prod. nr.	Prod. nr.	Prod. nr.	Prod. nr.	Prod. nr.	VPE
63	3	F33S257				F33S557	5
63	4	F43S257		F43S357	F43S457	F43S557	5
63	5	F53S257	F53S057	F53S357		F53S557	5

Flenscontactdozen recht

volgens IEC 60309, EN 60309, VDE 0623



Flenscontactdoos recht

watervdicht IP67

- HighPower-uitvoering
- met pilotcontact
- Schroefklemmen
- Contacten: Messing met CuBe lamellencontact

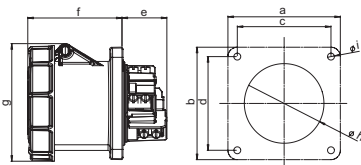

Aantal polen	3	4	5
Ampère	125		
a en b	120	120	120
c en d	100	100	100
e	48	48	48
f	101	101	101
g	126	126	126
h	90	90	90
i	8	8	8
Gewicht g/stuk	752	890	986

Spanning		230 V~	>50 V~	400 V~	440 V~	500 V~	
Frequentie		50/60 Hz	50/60 Hz	50/60 Hz	50/60 Hz	50/60 Hz	
Identificatie		3p = 6h 4p/5p = 9h	1h	3p = 9h 4p/5p = 6h	11h	7h	
Ampère	Polen	Prod. nr.	Prod. nr.	Prod. nr.	Prod. nr.	Prod. nr.	VPE
125	3	F34S257				F34S557	2
125	4	F44S257		F44S357	F44S457	F44S557	2
125	5	F54S257	F54S057	F54S357		F54S557	2

Flenscontactdozen schuin

volgens IEC 60309, EN 60309, VDE 0623



Flenscontactdoos schuin 20°

spatwaterdicht IP54

*spatwaterdicht IP44

- Schroefklemmen
- Met onvernikkelde contacten

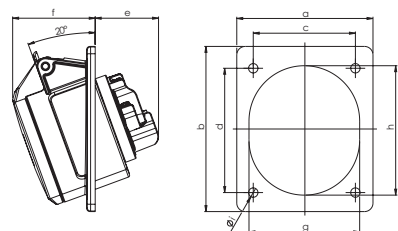

Aantal polen	3	4	5	3	4	5
Ampère	16			32		
Flens a	70	70	80	80	80	80
Flens b	85	85	97	97	97	97
Gatenafstand c	50	50	60	60	60	60
Gatenafstand d	65	65	73	73	73	73
e	38	38	38	48	48	48
f	47	47	49	54	54	55
g	51	56	65	65	65	70
h	61	67	76	75	75	80
i	5,5	5,5	5,5	5,5	5,5	5,5
Gewicht g/stuk	111	127	154	166	182	214

Spanning		110 V~	230 V~	400 V~	440 V~	500 V~	
Frequentie		50/60 Hz	50/60 Hz	50/60 Hz	50/60 Hz	50/60 Hz	
Identificatie		4h	3p = 6h 4p/5p = 9h	3p = 9h 4p/5p = 6h	11h	7h	
Ampère	Polen	Prod. nr.	Prod. nr.	Prod. nr.	Prod. nr.	Prod. nr.	VPE
16	3	F31S120	F31S220			F31S520	10
16*	4	F41S120	F41S220	F41S320	F41S420	F41S520	10
16	5		F51S220	F51S320		F51S520	10
32*	3	F32S120	F32S220			F32S520	10
32*	4	F42S120	F42S220	F42S320	F42S420	F42S520	10
32	5		F52S220	F52S320		F52S520	10

Flenscontactdozen schuin

volgens IEC 60309, EN 60309, VDE 0623

plug2power



Flenscontactdoos schuin 20°

spatwaterdicht IP54

*spatwaterdicht IP44

- aansluittechniek zonder schroeven (plug2power)
- Met vernikkelde contacten

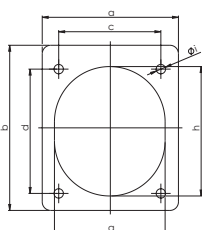
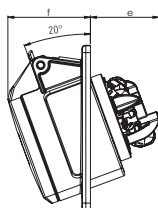

Aantal polen	3	4	5	3	4	5
Ampère	16			32		
Flens a	80	80	80	80	80	80
Flens b	97	97	97	97	97	97
Gatenafstand c	60	60	60	60	60	60
Gatenafstand d	73	73	73	73	73	73
e	41	41	41	48	48	48
f	47	47	49	54	54	55
g	51	56	65	65	65	70
h	61	67	76	75	75	80
i	5,5	5,5	5,5	5,5	5,5	5,5
Gewicht g/stuk	119	133	158	165	182	215

Spanning		110 V~	230 V~	400 V~	
Frequentie		50/60 Hz	50/60 Hz	50/60 Hz	
Identificatie		4h	3p = 6h 4p/5p = 9h	3p = 9h 4p/5p = 6h	
Ampère	Polen	Prod. nr.	Prod. nr.	Prod. nr.	VPE
16	3	F31SL1C	F31SL2C		10
16*	4	F41SL1C	F41SL2C	F41SL3C	10
16	5		F51SL2C	F51SL3C	10
32*	3	F32SL1C	F32SL2C		10
32*	4	F42SL1C	F42SL2C	F42SL3C	10
32	5		F52SL2C	F52SL3C	10



Flenscontactdoos schuin 20°

spatwaterdicht IP54

- Schroefklemmen
- Met onvernikkelde contacten

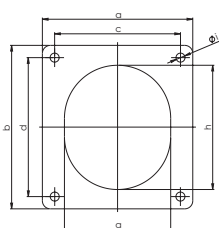
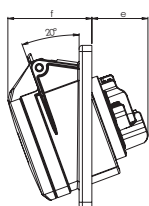

Aantal polen	5	5
Ampère	16	32
Flens a	92	92
Flens b	100	100
Gatenafstand c	77	77
Gatenafstand d	85	85
e	38	48
f	52	55
g	65	70
h	76	80
i	5,5	5,5
Gewicht g/stuk	175	246

Spanning		400 V~	
Frequentie		50/60 Hz	
Identificatie		3p = 9h 4p/5p = 6h	
Ampère	Polen	Prod. nr.	VPE
16	3	F51S333	10
32	4	F52S333	10

Flenscontactdozen schuin

volgens IEC 60309, EN 60309, VDE 0623



Flenscontactdoos schuin 20°

waterdicht IP67

- Schroefklemmen
- driedelig
- Met vernikkelde contacten

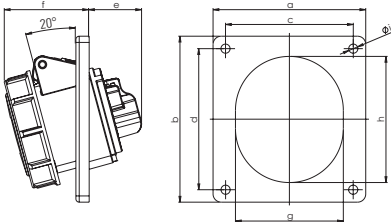

Aantal polen	3	4	5	3	4	5
Ampère	16			32		
Flens a	92	92	92	92	92	92
Flens b	100	100	100	100	100	100
Gatenafstand c	77	77	77	77	77	77
Gatenafstand d	85	85	85	85	85	85
e	33	34	38	48	48	48
f	53	55	58	62	62	62
g	51	56	65	65	65	70
h	61	67	76	75	75	80
i	5,5	5,5	5,5	5,5	5,5	5,5
Gewicht g/stuk	160	167	199	221	237	280

Spanning	110 V~	230 V~	400 V~	440 V~	500 V~		
Frequentie	50/60 Hz	50/60 Hz	50/60 Hz	50/60 Hz	50/60 Hz		
Identificatie	4h	3p = 6h 4p/5p = 9h	3p = 9h 4p/5p = 6h	11h	7h		
Ampère	Polen	Prod. nr.	Prod. nr.	Prod. nr.	Prod. nr.	Prod. nr.	VPE
16	3	F31S183	F31S283			F31S583	10
16	4	F41S183	F41S283	F41S383	F41S483	F41S583	10
16	5		F51S283	F51S383		F51S583	10
32	3	F32S183	F32S283			F32S583	10
32	4	F42S183	F42S283	F42S383	F42S483	F42S583	10
32	5		F52S283	F52S383		F52S583	10

plug  power



Flenscontactdoos schuin 20°

waterdicht IP67

- Schroefklemmen
- Met vernikkelde contacten

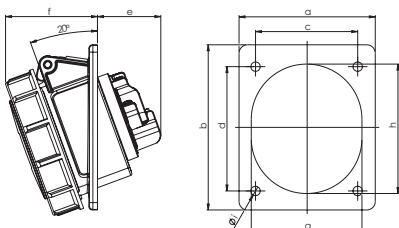

Aantal polen	3	4	5	3	4	5
Ampère	16			32		
Flens a	70	70	80	80	80	80
Flens b	85	85	97	97	97	97
Gatenafstand c	50	50	60	60	60	60
Gatenafstand d	65	65	73	73	73	73
e	38	38	38	48	48	48
f	50	52	55	59	59	61
g	51	56	65	65	65	70
h	61	67	76	75	75	80
i	5,5	5,5	5,5	5,5	5,5	5,5
Gewicht g/stuk	128	132	186	207	224	262

Spanning	230 V~	400 V~	440 V~	500 V~		
Frequentie	50/60 Hz	50/60 Hz	50/60 Hz	50/60 Hz		
Identificatie	3p = 6h 4p/5p = 9h	3p = 9h 4p/5p = 6h	11h	7h		
Ampère	Polen	Prod. nr.	Prod. nr.	Prod. nr.	Prod. nr.	VPE
16	3	F31S270			F31S570	10
16	4	F41S270	F41S370	F41S470	F41S570	10
16	5	F51S270	F51S370		F51S570	10
32	3	F32S270			F32S570	10
32	4	F42S270	F42S370	F42S470	F42S570	10
32	5	F52S270	F52S370		F52S570	10

Flenscontactdozen schuin

volgens IEC 60309, EN 60309, VDE 0623



Flenscontactdoos schuin 15°

waterdicht IP67

- HighPower-uitvoering
- met pilootcontact
- Schroefklemmen
- Contacten: Messing met CuBe lamellenkontakt
- Met flens 107 x 100 mm

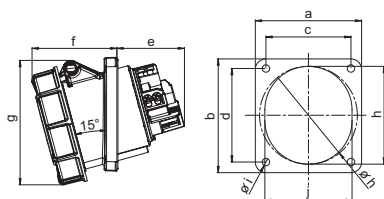

Aantal polen	3	4	5
Ampère	63		
Flens a	100	100	100
Flens b	107	107	107
Gatenafstand c	77	77	77
Gatenafstand d	85	85	85
e	64	64	64
f	80	80	80
g	119	119	119
h	92	92	92
i	7	7	7
j	82	82	82
Gewicht g/stuk	491	536	591

Spanning		230 V~	400 V~	440 V~	500 V~	
Frequentie		50/60 Hz	50/60 Hz	50/60 Hz	50/60 Hz	
Identificatie		3p = 6h 4p/5p = 9h	3p = 9h 4p/5p = 6h	11h	7h	
Ampère	Polen	Prod. nr.	Prod. nr.	Prod. nr.	Prod. nr.	VPE
63	3	F33S284			F33S584	10
63	4	F43S284	F43S384	F43S484	F43S584	10
63	5	F53S284	F53S384		F53S584	10



Flenscontactdoos schuin 15°

waterdicht IP67

- HighPower-uitvoering
- met pilootcontact
- Schroefklemmen
- Contacten: Messing met CuBe lamellenkontakt
- Met flens 114 x 114 mm

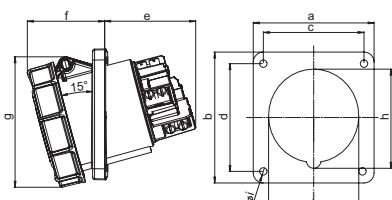

Aantal polen	3	4	5
Ampère	125		
Flens a	114	114	114
Flens b	114	114	114
Gatenafstand c	90	90	90
Gatenafstand d	90	90	90
e	92	92	92
f	77	77	77
g	130	130	130
h	102	102	102
i	7	7	7
j	90	90	90
Gewicht g/stuk	792	880	987

Spanning		230 V~	400 V~	440 V~	500 V~	
Frequentie		50/60 Hz	50/60 Hz	50/60 Hz	50/60 Hz	
Identificatie		3p = 6h 4p/5p = 9h	3p = 9h 4p/5p = 6h	11h	7h	
Ampère	Polen	Prod. nr.	Prod. nr.	Prod. nr.	Prod. nr.	VPE
125	3	F34S288			F34S588	10
125	4	F44S288	F44S388	F44S488	F44S588	10
125	5	F54S288	F54S388		F54S588	10

EventLine

volgens IEC 60309, EN 60309, VDE 0623

turn2fix



Stekker, zwart

spatwaterdicht IP44

- Schroefklemmen
- Snelsluitsysteem (turn2fix)
- Met onvernikkelde contacten

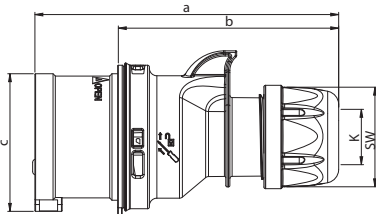

Aantal polen	3	4	5	3	4	5
Ampère	16			32		
a	122	128	134	150	150	155
b	86	92	98	104	104	109
c	47	53	61	63	63	70
K	6-15	6-15	8-16	11,5-20	11,5-20	11,5-22
SW	42	42	42	50	50	50
Gewicht g/stuk	109	128	151	181	201	232

Spanning	230 V~	400 V~		
Frequentie	50/60 Hz	50/60 Hz		
Identificatie	3p = 6h 4p/5p = 9h	3p = 9h 4p/5p = 6h		
Ampère	Polen	Prod. nr.	Prod. nr.	VPE
16	3	S31S20B		10
16	4		S41S30B	10
16	5		S51S30B	10
32	3	S32S20B		10
32	4		S42S30B	10
32	5		S52S30B	10

turn2fix



Koppeling, zwart

spatwaterdicht IP44

- Klapdeksel met duimgreep
- Schroefklemmen
- Snelsluitsysteem (turn2fix)
- Met onvernikkelde contacten

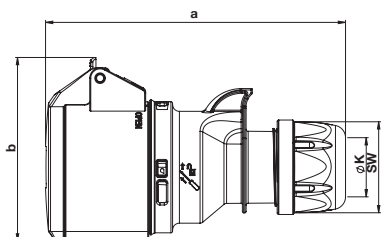

Aantal polen	3	4	5	3	4	5
Ampère	16			32		
a	133	138	145	161	161	168
b	76	80	89	91	94	100
K	6-15	6-15	8-16	11,5-20	11,5-20	11,5-22
SW	42	42	42	50	50	50
Gewicht g/stuk	134	161	188	228	244	270

Spanning	230 V~	400 V~		
Frequentie	50/60 Hz	50/60 Hz		
Identificatie	3p = 6h 4p/5p = 9h	3p = 9h 4p/5p = 6h		
Ampère	Polen	Prod. nr.	Prod. nr.	VPE
16	3	K31S20B		10
16	4		K41S30B	10
16	5		K51S30B	10
32	3	K32S20B		10
32	4		K42S30B	10
32	5		K52S30B	10

EventLine

volgens IEC 60309, EN 60309, VDE 0623



Flenscontactdoos recht, zwart

spatwaterdicht IP44

- Schroefklemmen
- Met onvernikkelde contacten

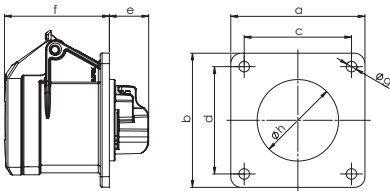

Aantal polen	3	4	5	3	4	5
Ampère	16			32		
a en b	70	70	70	70	70	70
c en d	56	56	56	56	56	56
e	21	21	21	23	23	23
f	55	55	55	67	67	67
g	5,5	5,5	5,5	5,5	5,5	5,5
h	43	45	55	55	55	58
Gewicht g/stuk	115	127	141	162	178	206

Spanning		230 V~	400 V~	
Frequentie		50/60 Hz	50/60 Hz	
Identificatie		3p = 6h 4p/5p = 9h	3p = 9h 4p/5p = 6h	
Ampère	Polen	Prod. nr.	Prod. nr.	VPE
16	3	F31S20B		10
16	4		F41S30B	10
16	5		F51S30B	10
32	3	F32S20B		10
32	4		F42S30B	10
32	5		F52S30B	10



Flenscontactdoos schuin 20°, zwart

spatwaterdicht IP44

- Schroefklemmen
- Met onvernikkelde contacten

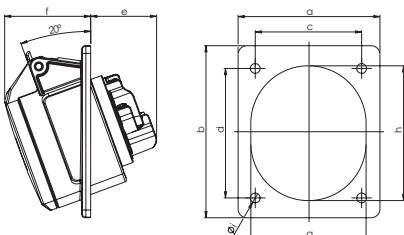

Aantal polen	3	4	5	3	4	5
Ampère	16			32		
Flens a	80	80	80	80	80	80
Flens b	97	97	97	97	97	97
Gatenafstand c	60	60	60	60	60	60
Gatenafstand d	73	73	73	73	73	73
e	38	38	38	48	48	48
f	47	47	49	54	54	55
g	51	56	65	65	65	70
h	61	67	76	75	75	80
i	5,5	5,5	5,5	5,5	5,5	5,5
Gewicht g/stuk	116	132	154	166	182	214

Spanning		230 V~	400 V~	
Frequentie		50/60 Hz	50/60 Hz	
Identificatie		3p = 6h 4p/5p = 9h	3p = 9h 4p/5p = 6h	
Ampère	Polen	Prod. nr.	Prod. nr.	VPE
16	3	F31S22B		10
16	4		F41S32B	10
16	5		F51S32B	10
32	3	F32S22B		10
32	4		F42S32B	10
32	5		F52S32B	10

Container-connectoren



Container-stekkers

- waterdicht IP67
- Schroefklemmen
 - Snelsluitsysteem (turn2fix)
 - 32A 4p 3h 440V
 - Met vernikkelde contacten

Verp.-eenheid: 10 stuks
Prod. Nr. S42SC5

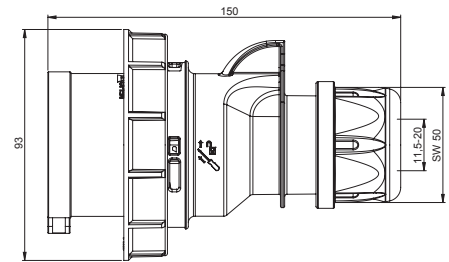

Container-koppeling

- waterdicht IP67
- Schroefklemmen
 - Snelsluitsysteem (turn2fix)
 - 32A 4p 3h 440V
 - Met vernikkelde contacten

Verp.-eenheid: 10 stuks
Prod. Nr. K42SC5

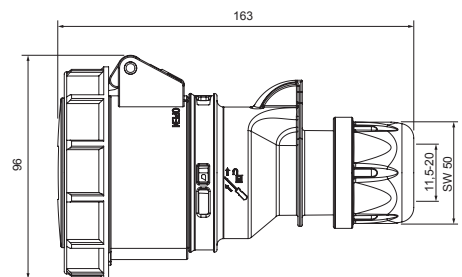

Container-wandcontactdoos

- waterdicht IP67
- Schroefklemmen
 - Snelsluitsysteem (turn2fix)
 - 32A 4p 3h 440V
 - Met vernikkelde contacten

Verp.-eenheid: 5 stuks
Prod. Nr. D42SC5

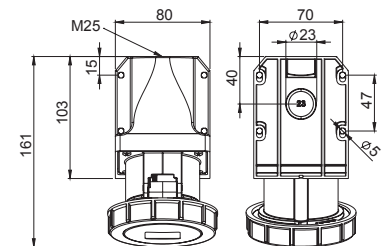

Höhe= 108mm
 Neigung=15°



Container-flenscontactdoos recht

- waterdicht IP67
- Schroefklemmen
 - Snelsluitsysteem (turn2fix)
 - 32A 4p 3h 440V
 - Met vernikkelde contacten

Verp.-eenheid: 10 stuks
Prod. Nr. F42SC50

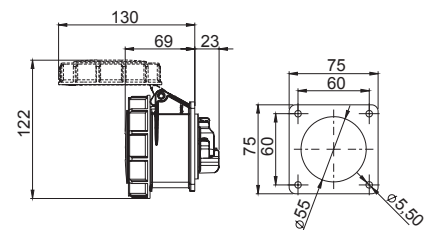

Container-flenscontactdoos schuin

- waterdicht IP67
- Schroefklemmen
 - Snelsluitsysteem (turn2fix)
 - 32A 4p 3h 440V
 - Met vernikkelde contacten

Verp.-eenheid: 10 stuks
Prod. Nr. F42SC83

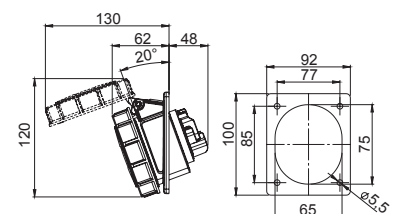

Laagspanningsconnectoren

volgens IEC 60309, EN 60309, VDE 0623

turn2fix



Stekker

spatwaterdicht IP44

- Schroefklemmen
- Snelsluitstelsysteem (turn2fix)
- Vernikkelde contacten

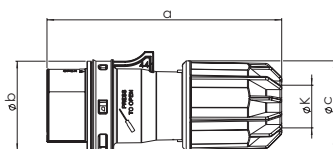

Aantal polen	2	3	2	3
Ampère	16		32	
a	135	135	135	135
b	51	51	51	51
c	48	48	48	48
K	9,5-24	9,5-24	9,5-24	9,5-24
Gewicht g/stuk	142	160	142	160

Spanning		24 V~	42 V~	24/42 V~	
Frequentie		50/60 Hz	50/60 Hz	100-200 Hz	
Identificatie		zonder hulpnok	12h	4h	
Ampère	Polen	Prod. nr.	Prod. nr.	Prod. nr.	VPE
16	3	S01S20	S01S60	S01S10	10
16	4	S11S20	S11S60	S11S10	10
32	4	S02S20	S02S60	S02S10	10
32	5	S12S20	S12S60	S12S10	10

turn2fix



Stekker

waterdicht IP67

- Schroefklemmen
- Snelsluitstelsysteem (turn2fix)
- Vernikkelde contacten

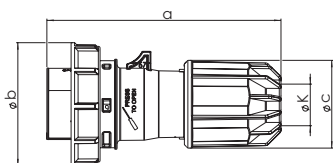

Aantal polen	2	3	2	3
Ampère	16		32	
a	124	131	146	152
b	79	87	93	100
c	48	48	48	48
K	9,5-24	9,5-24	9,5-24	9,5-24
Gewicht g/stuk	164	182	164	182

Spanning		24 V~	42 V~	24/42 V~	
Frequentie		50/60 Hz	50/60 Hz	100-200 Hz	
Identificatie		zonder hulpnok	12h	4h	
Ampère	Polen	Prod. nr.	Prod. nr.	Prod. nr.	VPE
16	3	S01S25	S01S65	S01S15	10
16	4	S11S25	S11S65	S11S15	10
32	4	S02S25	S02S65	S02S15	10
32	5	S12S25	S12S65	S12S15	10

Laagspanningsconnectoren

volgens IEC 60309, EN 60309, VDE 0623

turn2fix



Koppeling

spatwaterdicht IP44

- Schroefklemmen
- Snelsluitsysteem (turn2fix)
- Vernikkelde contacten

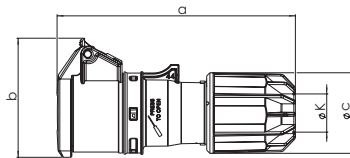

Aantal polen	2	3	2	3
Ampère	16		32	
a	150	150	150	150
b	75	75	75	75
c	48	48	48	48
K	9,5-24	9,5-24	9,5-24	9,5-24
Gewicht g/stuk	179	199	179	199

Spanning		24 V~	42 V~	24/42 V~	
Frequentie		50/60 Hz	50/60 Hz	100-200 Hz	
Identificatie		zonder hulpnok	12h	4h	
Ampère	Polen	Prod. nr.	Prod. nr.	Prod. nr.	VPE
16	2	K01S20	K01S60	K01S10	10
16	3	K11S20	K11S60	K11S10	10
32	2	K02S20	K02S60	K02S10	10
32	3	K12S20	K12S60	K12S10	10

turn2fix



Koppeling

waterdicht IP67

- Schroefklemmen
- Snelsluitsysteem (turn2fix)
- Vernikkelde contacten

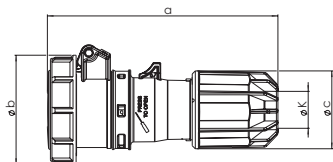

Aantal polen	2	3	2	3
Ampère	16		32	
a	150	150	150	150
b	78	78	78	78
c	48	48	48	48
K	9,5-24	9,5-24	9,5-24	9,5-24
Gewicht g/stuk	199	219	199	219

Spanning		24 V~	42 V~	24/42 V~	
Frequentie		50/60 Hz	50/60 Hz	100-200 Hz	
Identificatie		zonder hulpnok	12h	4h	
Ampère	Polen	Prod. nr.	Prod. nr.	Prod. nr.	VPE
16	2	K01S25	K01S65	K01S15	10
16	3	K11S25	K11S65	K11S15	10
32	2	K02S25	K02S65	K02S15	10
32	3	K12S25	K12S65	K12S15	10

Laagspanningsconnectoren

volgens IEC 60309, EN 60309, VDE 0623



Flenscontactdoos recht

spatwaterdicht IP44

- Met vernikkelde contacten

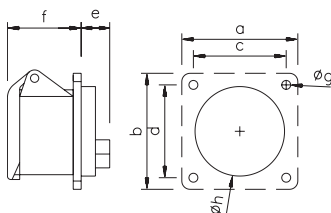

Aantal polen	2	3	2	3
Ampère	16		32	
a en b	55	55	55	55
c en d	45	45	45	45
e	19	19	19	19
f	47	47	47	47
g	4,5	4,5	4,5	4,5
h	43	43	43	43
Gewicht g/stuk	108	128	108	128

Spanning		24 V~	42 V~	24/42 V~		
Frequentie		50/60 Hz	50/60 Hz	100-200 Hz		
Identificatie		zonder hulpnok	12h	4h		
Ampère	Polen	Prod. nr.	Prod. nr.	Prod. nr.	VPE	
16	2	F01S203	F01S603	F01S103	10	
16	3	F11S203	F11S603	F11S103	10	
32	2	F02S203	F02S603	F02S103	10	
32	3	F12S203	F12S603	F12S103	10	



Wandcontactdoos

spatwaterdicht IP44

- Kabelinvoer boven of achter
- Met vernikkelde contacten

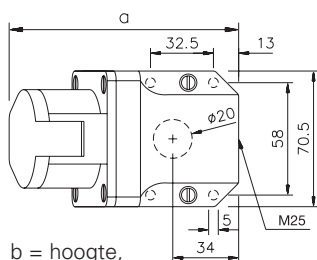

b = hoogte,
Hoek = 15°

Aantal polen	2	3	2	3
Ampère	16		32	
a	119	119	119	119
b	85	85	85	85
Gewicht g/stuk	198	215	198	215

Spanning		24 V~	42 V~	24/42 V~		
Frequentie		50/60 Hz	50/60 Hz	100-200 Hz		
Identificatie		zonder hulpnok	12h	4h		
Ampère	Polen	Prod. nr.	Prod. nr.	Prod. nr.	VPE	
16	2	D01S20	D01S60	D01S10	10	
16	3	D11S20	D11S60	D11S10	10	
32	2	D02S20	D02S60	D02S10	10	
32	3	D12S20	D12S60	D12S10	10	

Laagspanningsconnectoren

volgens IEC 60309, EN 60309, VDE 0623



Flenscontactdoos recht

waterdicht IP67

- Schroefklemmen
- Met vernikkelde contacten

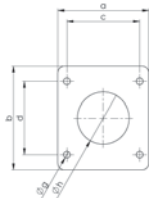
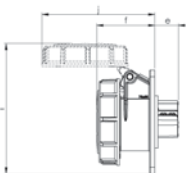

Aantal polen	2	3	2	3
Ampère	16		32	
a	54	54	54	54
b	60	60	60	60
c	44	44	44	44
d	44	44	44	44
e	19	19	19	19
f	48	48	48	48
g	5,5	5,5	5,5	5,5
h	43	43	43	43
Gewicht g/stuk	131	151	131	151

Spanning		24 V~	42 V~	24/42 V~		
Frequentie		50/60 Hz	50/60 Hz	100-200 Hz		
Identificatie		zonder hulpnok	12h	4h		
Ampère	Polen	Prod. nr.	Prod. nr.	Prod. nr.	VPE	
16	2	F01S254	F01S654	F01S154	10	
16	3	F11S254	F11S654	F11S154	10	
32	2	F02S254	F02S654	F02S154	10	
32	3	F12S254	F12S654	F12S154	10	

Industriële connectoren

volgens IEC 60309, EN 60309, VDE 0623

Volgens VDE 0100-550 zijn alleen ronde connectoren volgens VDE 0623 goedgekeurd als draaistroomconnectoren. Uitzonderingen: Huishoudelijke installatie, naaistudio's, laboratoria en dergelijke (hier wordt nog steeds PERILEX gebruikt).

Op bouwplaatsen geldt ook voor wisselstroomnetten dat naast SCHUKO-connectoren voor moeilijke omstandigheden ook ronde connectoren volgens VDE 0623 van het type EN 60309-2 zijn voorgeschreven. Dit geldt ook voor landbouwbedrijven.

Op camping- en bootligplaatsen en voor aansluiting op caravans zijn volgens VDE 0100-721 ronde connectoren volgens VDE 0623 voorgeschreven in type EN 60309-2. Dit geldt ook voor voertuigen en caravans in de showroom

Ronde connectoren in UL-versie volgens UL 1682/86 zijn op aanvraag verkrijgbaar.

Tijdpositie van het veiligheidscontact en kleurcodering
Aanzicht van de voorzijde van de koppelcontactdozen op de contactbussen

	4 h	9 h	6 h	11 h	7 h	5 h	12 h	1 h	10 h	2 h	3 h	8 h
Frequentie (Hz)	50-60	50-60	50-60	60	50-60	50-60	50-60	-	100-300	boven 300 tot 500	50-60	
Spanning (V)	57/100 tot 75/130	120/208 tot 144/250	200/346 tot 240/415	250/400 tot 265/460	277/480 tot 288/500	347/600 tot 400/690		boven 50	boven 50	boven 50	220/380 tot 250/440 16 + 32 A	
5-pol. 3-pol. + N + ⊕												1)
Spanning (V)	100-130	200-250	380-415	440-460	480-500	600-690	Spanningen na scheidingstransformator*		boven 50	boven 50	380-440 alleen voor 16 + 32 A	
4-pol. 3-pol. + ⊕												1)
Spanning (V)	100-130	380-415	200-250		480-500	277*	Spanningen na scheidingstransformator		*		boven 50 tot 250 DC	boven 250 DC
3-pol. 2-pol. + ⊕												

63 A + 125 A-connectoren met pilotcontact

* Deze versies maken geen deel uit van de genoemde normen.

1 alleen voor koelcontainers

Positie van de hulpnok ten opzichte van de basisnok voor spanningen tot 50 V en frequenties tot 500 Hz en kleurcodering
Aanzicht van de voorzijde van de koppelcontactdozen op de contactbussen

	-	12 h	4 h	2 h	3 h	11 h	10 h
Frequentie (Hz)	50-60	50-60	100-200	300	400	boven 400 tot 500	DC
Spanning (V)	20-25	40-50	40-50	tot 50	tot 50	tot 50	tot 50
2-polig							
3-polig							

Industriële connectoren

volgens IEC 60309, EN 60309, VDE 0623

Industriële connector

De algemeen gebruikte benaming "CEE17-connector" komt uit de standaardisatie van CEE-Publicatie 17 uit 1966, die vandaag de dag niet meer geldig is.

Hier zijn de eisen voor connectoren voor industriële doeleinden beschreven door de INTERNATIONALE COMMISSIE VOOR REGLEMENTEN VOOR DE BEOORDELING VAN ELEKTRONISCHE PRODUCTEN (afgekort CEE).

Standaardisatie IEC

Vandaag de dag zijn "CEE17 connectoren" voor industriële toepassingen internationaal gestandaardiseerd door IEC 60309-1 en IEC 60309-2. De IEC (International Electrotechnical Commission), gevestigd in Genève, is een standaardisatie-instelling die wereldwijd actief is op het gebied van elektrotechniek en elektronica.

Standaardisatie CENELEC

Het Europees Comité voor Elektrotechnische standaardisatie (kortweg CENELEC) heeft de normen van IEC 60309 ongewijzigd overgenomen in de Europese norm EN 60309. CENELEC is verantwoordelijk voor de Europese standaardisatie op het gebied van elektrotechniek.

De CENELEC-lidstaten zijn de nationale elektrotechnische comités van België, Denemarken, Duitsland, Estland, Finland, Frankrijk, Griekenland, Ierland, IJsland, Italië, Letland, Litouwen, Luxemburg, Malta, Nederland, Noorwegen, Oostenrijk, Polen, Portugal, Roemenië, Zweden, Zwitserland, Slowakije, Slovenië, Spanje, Tsjechië, Hongarije, het Verenigd Koninkrijk en Cyprus.

RoHS - richtlijn 2002/95/EG

De richtlijn inzake stoffenverboden regelt de beperkingen op het op de markt brengen van lood, cadmium, kwik, zeswaardig chroom, polybroombifenylen (PBB's) en polybroomdifenolether (PBDE's) in elektrische en elektronische apparatuur.

Onze industriële connectoren vallen niet onder de RoHS-richtlijn 2002/95/EG. Als ze echter worden geïnstalleerd in apparaten of hun componenten die onder deze richtlijn vallen, voldoen ze aan de beperkingen van de RoHS.

De volgende apparaten en de in deze apparaten geïnstalleerde componenten vallen onder RoHS richtlijn: Grote huishoudelijke apparaten, kleine huishoudelijke apparaten, IT- en telecommunicatieapparatuur, consumentenelektronica, verlichtingsarmaturen, gloeilampen en armaturen in huishoudens, elektronische transformatoren ingebouwd in armaturen, schakelaars, bewegingsmelders en voorschakelapparaten, elektrisch en elektronisch gereedschap (met uitzondering van groot stationair industrieel gereedschap), speelgoed en sport- en vrijetijdspartijapparatuur, automatische uitvoerapparaten, en aansluitkabels en -stekers die op bovengenoemde apparatuur zijn aangesloten.

Systeem voor compatibiliteit en onmiskenbaarheid

Door de internationale standaardisatie van connectoren zijn de belangrijkste afmetingen zo ontworpen dat connectoren met dezelfde nominale stroomsterkte, nominale bedrijfsspanningsbereiken, aantal polen en frequentie van verschillende fabrikanten compatibel zijn.

Bovendien wordt door 12 verschillende gestandaardiseerde klokwijzerstanden van het veiligheidscontact ten opzichte van de onmiskenbaarheidsnok op de beschermkraag op doeltreffende wijze verhinderd dat apparaten met verschillende nominale waarden op elkaar worden aangesloten.

Als bijvoorbeeld het nummer "9" gevolgd door de letter "h" (d.w.z. klok) op het etiket van een industriële connector staat, geeft dit de positie van de veiligheidscontactbus aan als je naar de voorkant van een stopcontact of koppeling kijkt en deze vergelijkt met de wijzerplaat van een klok. De groef in de beschermkraag moet op 6 uur worden gedraaid.

Productnummer-index

PROD.-NR.	PAGINA
A31S11	18
A31S12	17
A31S16	18
A31S21	18
A31S22	17
A31S23	17
A31S26	18
A31S51	18
A31S52	17
A31S56	18
A32S11	18
A32S12	17
A32S16	18
A32S21	18
A32S22	17
A32S26	18
A32S51	18
A32S52	17
A32S56	18
A33S27	19
A33S57	19
A34S27	19
A34S57	19
A41S11	18
A41S12	17
A41S16	18
A41S21	18
A41S22	17
A41S26	18
A41S31	18
A41S32	17
A41S36	18
A41S51	18
A41S52	17
A41S56	18
A42S11	18
A42S12	17
A42S16	18
A42S21	18
A42S22	17
A42S26	18
A42S31	18
A42S32	17
A42S36	18
A42S51	18
A42S52	17
A42S56	18
A43S27	19
A43S37	19
A43S57	19
A44S27	19
A44S37	19
A44S57	19
A51S21	18
A51S22	17
A51S26	18
A51S31	18
A51S32	17
A51S34	17
A51S36	18
A51S51	18
A51S52	17

PROD.-NR.	PAGINA
A51S56	18
A52S21	18
A52S22	17
A52S26	18
A52S31	18
A52S32	17
A52S34	17
A52S36	18
A52S51	18
A52S52	17
A52S56	18
A53S27	19
A53S37	19
A53S57	19
A54S27	19
A54S37	19
A54S57	19
D01S10	41
D01S20	41
D01S60	41
D02S10	41
D02S20	41
D02S60	41
D11S10	41
D11S20	41
D11S60	41
D12S10	41
D12S20	41
D12S60	41
D31S11	25
D31S15	26
D31S21	25
D31S22	25
D31S25	26
D31S51	25
D31S55	26
D31SL10	24
D31SL20	24
D32S11	25
D32S15	26
D32S21	25
D32S22	25
D32S25	26
D32S51	25
D32S55	26
D32SL10	24
D32SL20	24
D33S26	26
D33S56	26
D34S27	27
D34S57	27
D41S11	25
D41S15	26
D41S21	25
D41S22	25
D41S25	26
D41S31	25
D41S32	25
D41S331	28
D41S333	28
D41S35	26
D41S45	26

PROD.-NR.	PAGINA
D41S51	25
D41S55	26
D41SL10	24
D41SL20	24
D41SL30	24
D42S11	25
D42S15	26
D42S21	25
D42S22	25
D42S25	26
D42S31	25
D42S32	25
D42S331	28
D42S333	28
D42S35	26
D42S45	26
D42S51	25
D42S55	26
D42SC5	38
D42SL10	24
D42SL20	24
D42SL30	24
D43S26	26
D43S36	26
D43S37	27
D43S46	26
D43S56	26
D44S27	27
D44S37	27
D44S47	27
D44S57	27
D51S21	25
D51S22	25
D51S25	26
D51S31	25
D51S32	25
D51S331	28
D51S333	28
D51S35	26
D51S51	25
D51S55	26
D51SL20	24
D51SL30	24
D52S21	25
D52S22	25
D52S25	26
D52S31	25
D52S32	25
D52S331	28
D52S333	28
D52S35	26
D52S51	25
D52S55	26
D52SL20	24
D52SL30	24
D53S26	26
D53S36	26
D53S37	27
D53S56	26
D54S27	27
D54S37	27
D54S57	27

PROD.-NR.	PAGINA
F01S103	41
F01S154	42
F01S203	41
F01S254	42
F01S603	41
F01S654	42
F02S103	41
F02S154	42
F02S203	41
F02S254	42
F02S603	41
F02S654	42
F11S103	41
F11S154	42
F11S203	41
F11S254	42
F11S603	41
F11S654	42
F12S103	41
F12S154	42
F12S203	41
F12S254	42
F12S603	41
F12S654	42
F31S050	31
F31S100	29
F31S102	30
F31S120	32
F31S150	31
F31S183	34
F31S200	29
F31S201	30
F31S202	30
F31S203	30
F31S20B	37
F31S220	32
F31S22B	37
F31S250	31
F31S270	34
F31S283	34
F31S500	29
F31S520	32
F31S550	31
F31S570	34
F31S583	34
F31SL11	29
F31SL1C	33
F31SL21	29
F31SL2C	33
F32S050	31
F32S100	29
F32S120	32
F32S150	31
F32S183	34
F32S200	29
F32S201	30
F32S20B	37
F32S220	32
F32S22B	37
F32S250	31
F32S270	34
F32S283	34

Productnummer-index

PROD.-NR.	PAGINA
F32S500	29
F32S520	32
F32S550	31
F32S570	34
F32S583	34
F32SL11	29
F32SL1C	33
F32SL21	29
F32SL2C	33
F33S257	31
F33S284	35
F33S557	31
F33S584	35
F34S257	32
F34S288	35
F34S557	32
F34S588	35
F41S100	29
F41S120	32
F41S150	31
F41S183	34
F41S200	29
F41S201	30
F41S220	32
F41S250	31
F41S270	34
F41S283	34
F41S300	29
F41S301	30
F41S30B	37
F41S320	32
F41S32B	37
F41S350	31
F41S370	34
F41S383	34
F41S400	29
F41S420	32
F41S450	31
F41S470	34
F41S483	34
F41S500	29
F41S520	32
F41S550	31
F41S570	34
F41S583	34
F41SL11	29
F41SL1C	33
F41SL21	29
F41SL2C	33
F41SL31	29
F41SL3C	33
F42S100	29
F42S120	32
F42S150	31
F42S183	34
F42S200	29
F42S201	30
F42S220	32
F42S250	31
F42S270	34
F42S283	34
F42S300	29

PROD.-NR.	PAGINA
F42S301	30
F42S30B	37
F42S320	32
F42S32B	37
F42S350	31
F42S370	34
F42S383	34
F42S400	29
F42S420	32
F42S450	31
F42S470	34
F42S483	34
F42S500	29
F42S520	32
F42S550	31
F42S570	34
F42S583	34
F42SC50	38
F42SC83	38
F42SL11	29
F42SL1C	33
F42SL21	29
F42SL2C	33
F42SL31	29
F42SL3C	33
F43S257	31
F43S284	35
F43S357	31
F43S384	35
F43S457	31
F43S484	35
F43S557	31
F43S584	35
F44S257	32
F44S288	35
F44S357	32
F44S388	35
F44S457	32
F44S488	35
F44S557	32
F44S588	35
F51S050	31
F51S200	29
F51S201	30
F51S220	32
F51S250	31
F51S270	34
F51S283	34
F51S300	29
F51S301	30
F51S30B	37
F51S320	32
F51S32B	37
F51S333	33
F51S350	31
F51S370	34
F51S383	34
F51S500	29
F51S520	32
F51S550	31
F51S570	34
F51S583	34

PROD.-NR.	PAGINA
F51SL21	29
F51SL2C	33
F51SL31	29
F51SL3C	33
F52S050	31
F52S200	29
F52S201	30
F52S220	32
F52S250	31
F52S270	34
F52S283	34
F52S300	29
F52S301	30
F52S30B	37
F52S320	32
F52S32B	37
F52S333	33
F52S350	31
F52S370	34
F52S383	34
F52S500	29
F52S520	32
F52S550	31
F52S570	34
F52S583	34
F52SL21	29
F52SL2C	33
F52SL31	29
F52SL3C	33
F53S057	31
F53S257	31
F53S284	35
F53S357	31
F53S384	35
F53S557	31
F53S584	35
F54S057	32
F54S257	32
F54S288	35
F54S357	32
F54S388	35
F54S557	32
F54S588	35
G31S10	15
G31S20	15
G31S22	15
G31S50	15
G32S10	15
G32S20	15
G32S22	15
G32S50	15
G33S25	16
G33S55	16
G34S25	16
G34S55	16
G41S10	15
G41S20	15
G41S22	15
G41S30	15
G41S40	15
G41S50	15
G42S10	15

PROD.-NR.	PAGINA
G42S20	15
G42S22	15
G42S30	15
G42S40	15
G42S50	15
G43S25	16
G43S35	16
G43S55	16
G44S25	16
G44S35	16
G44S55	16
G51S20	15
G51S30	15
G51S30P	20
G51S32	15
G51S50	15
G52S20	15
G52S30	15
G52S30P	20
G52S32	15
G52S50	15
G53S25	16
G53S35	16
G53S55	16
G54S25	16
G54S35	16
G54S55	16
K01S10	40
K01S15	40
K01S20	40
K01S25	40
K01S60	40
K01S65	40
K02S10	40
K02S15	40
K02S20	40
K02S25	40
K02S60	40
K02S65	40
K11S10	40
K11S15	40
K11S20	40
K11S25	40
K11S60	40
K11S65	40
K12S10	40
K12S15	40
K12S20	40
K12S25	40
K12S60	40
K12S65	40
K31S05	23
K31S10	22
K31S15	23
K31S20	22
K31S20B	36
K31S25	23
K31S50	22
K31S55	23
K31SL10	22
K31SL20	22
K32S05	23

Productnummer-index

PROD.-NR.	PAGINA
K32S10	22
K32S15	23
K32S20	22
K32S20B	36
K32S25	23
K32S50	22
K32S55	23
K32SL10	22
K32SL20	22
K33S20	23
K33S25	24
K33S50	23
K33S55	24
K34S25	24
K34S55	24
K41S10	22
K41S15	23
K41S20	22
K41S25	23
K41S30	22
K41S30B	36
K41S35	23
K41S40	22
K41S45	23
K41S50	22
K41S55	23
K41SL10	22
K41SL20	22
K41SL30	22
K42S10	22
K42S15	23
K42S20	22
K42S25	23
K42S30	22
K42S30B	36
K42S35	23
K42S40	22
K42S45	23
K42S50	22
K42S55	23
K42SC5	38
K42SL10	22
K42SL20	22
K42SL30	22
K43S20	23
K43S25	24
K43S30	23
K43S35	24
K43S45	24
K43S50	23
K43S55	24
K44S25	24
K44S35	24
K44S45	24
K44S55	24
K51S05	23
K51S20	22
K51S25	23
K51S30	22
K51S30B	36
K51S35	23
K51S50	22

PROD.-NR.	PAGINA
K51S55	23
K51SL20	22
K51SL30	22
K52S05	23
K52S20	22
K52S25	23
K52S30	22
K52S30B	36
K52S35	23
K52S50	22
K52S55	23
K52SL20	22
K52SL30	22
K53S05	24
K53S20	23
K53S25	24
K53S30	23
K53S35	24
K53S50	23
K53S55	24
K54S05	24
K54S25	24
K54S35	24
K54S55	24
S01S10	39
S01S15	39
S01S20	39
S01S25	39
S01S60	39
S01S65	39
S02S10	39
S02S15	39
S02S20	39
S02S25	39
S02S60	39
S02S65	39
S11S10	39
S11S15	39
S11S20	39
S11S25	39
S11S60	39
S11S65	39
S12S10	39
S12S15	39
S12S20	39
S12S25	39
S12S60	39
S12S65	39
S31S05	13
S31S10	12
S31S15	13
S31S20	12
S31S20B	36
S31S22	14
S31S25	13
S31S50	12
S31S55	13
S31SL10	12
S31SL20	12
S32S05	13
S32S10	12
S32S15	13

PROD.-NR.	PAGINA
S32S20	12
S32S20B	36
S32S25	13
S32S50	12
S32S55	13
S32SL10	12
S32SL20	12
S33S20	13
S33S25	14
S33S50	13
S33S55	14
S34S25	14
S34S55	14
S41S10	12
S41S15	13
S41S20	12
S41S25	13
S41S30	12
S41S30B	36
S41S35	13
S41S40	12
S41S45	13
S41S50	12
S41S55	13
S41SL10	12
S41SL20	12
S41SL30	12
S42S10	12
S42S15	13
S42S20	12
S42S25	13
S42S30	12
S42S30B	36
S42S35	13
S42S40	12
S42S45	13
S42S50	12
S42S55	13
S42SC5	38
S42SL10	12
S42SL20	12
S42SL30	12
S43S20	13
S43S25	14
S43S30	13
S43S35	14
S43S45	14
S43S50	13
S43S55	14
S44S25	14
S44S35	14
S44S45	14
S44S55	14
S51S05	13
S51S20	12
S51S25	13
S51S30	12
S51S30B	36
S51S30P	20
S51S32	14
S51S35	13
S51S50	12

PROD.-NR.	PAGINA
S51S55	13
S51SL20	12
S51SL30	12
S52S05	13
S52S20	12
S52S25	13
S52S30	12
S52S30B	36
S52S30P	20
S52S35	13
S52S50	12
S52S55	13
S52SL20	12
S52SL30	12
S53S05	14
S53S20	13
S53S25	14
S53S30	13
S53S35	14
S53S50	13
S53S55	14
S54S05	14
S54S25	14
S54S35	14
S54S55	14
VD0163	21
VD0164	21
VD0165	21
VD0323	21
VD0325	21
WS0633	21
WS1253	21

© Copyright 2020

Deze catalogus en de inhoud ervan zijn auteursrechtelijk beschermd. Reproductie of publicatie van zelfs afzonderlijke teksten, afbeeldingen, foto's is strikt verboden en alleen met de uitdrukkelijke schriftelijke toestemming van ABL SURSUM Bayerische Elektrozubehör GmbH & Co. KG toegestaan. Afwijkingen bij technische gegevens en afbeeldingen en bij de leverbaarheid zijn voorbehouden.



ABL Nederland B.V.
Meander 251
6825 MC Arnhem

Postbox 5085
6802 EB Arnhem
Tel. 0031 26 3673400

abl_nederland@abl.de
www.abl.de
www.ablmobility.de