

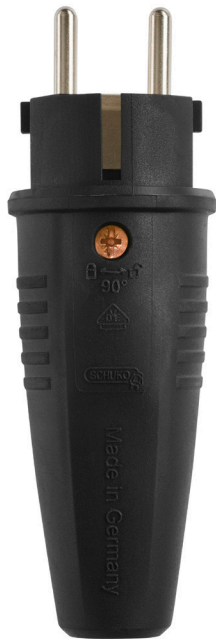





Expert

French/Belgian plug



Connector for maximum mechanical loads with ABL quick-release mechanism.

-  French/Belgian standard
-  Quick-release mechanism
-  IP44
-  UV- and media resistant
-  Convenient connection space up to 2.5 mm²
-  Triple laminated seal



Plug with double earthing system



General information

| | |
|---|-------------------|
| Colours | ● |
| Product range | 1509 |
| Commodity code | 85366990 |
| Packaging unit | 20 unit |
| Packing (l × w × h) | 286 × 227 × 96 mm |
| Available with increased contact protection | – |

Electrical parameters

| | |
|-----------------|---------|
| Current | 16 A |
| Voltage | 250 V |
| Number of poles | 2P + PE |

Standards/guidelines

| | |
|-----------------------|---|
| According to standard | DIN VDE 0620 NF C61-314 NBN C61-112 |
| Certification labels |    |

Operating conditions

| | |
|-----------------------|--|
| Storage temperature | -25 °C to +70 °C |
| Operating temperature | -25 °C to +40 °C |
| Relative humidity | 5 to 95%, no condensation |
| IP rating | IP44, IK08 |
| Resistance | UV- and media resistant* Very good resistance to most oils, greases, solvents and cleaning agents, hydrocarbons as well as organic and inorganic bases in normal concentrations |

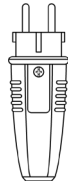

Plug with double earthing system

Materials

| | |
|----------------|--------------|
| Contact holder | Elamid |
| Housing | Rubber (TPE) |

Connection cable

| | |
|------------------------------------|--|
| Cross section | 3 × 0.75 mm ² - 3 × 2.5 mm ² |
| Cable diameter | 6 - 12 mm |
| Sheath insulation stripping length | 42 - 44 mm |
| Core insulation stripping length | 8 - 10 mm |

Connection screws

| | |
|---------------------------------------|--------------------------------------|
| Max. torque screws terminals L-N / PE | 0.5 Nm |
| Screw drive terminals L-N / PE | Combined slot / PZ1 |
| Max. torque for screws housing | Quick-release mechanism 90° rotation |
| Screw drive housing | Combined slot / PZ1 |
| Max. torque for screws strain relief | 0.5 Nm |
| Screw drive strain relief | Combined slot / PZ1 |

Additional technical information

| | |
|---------------------------------|--|
| Turning the strain relief clamp | recommended for cable diameters ≤ 8 mm |
| External screw connection | — |

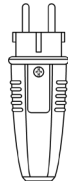

Plug with double earthing system

Product numbers

| | |
|---------|-----------|
| ● Black | 100000043 |
|---------|-----------|

EAN/GTIN numbers

| | |
|---------|---------------|
| ● Black | 4011721188720 |
|---------|---------------|

Dimensional drawing – plug with double earthing system

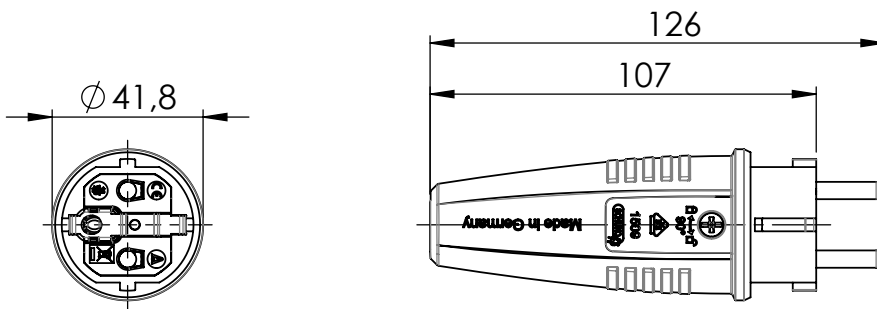

Subject to technical changes.

*If there are special requirements for the application in terms of load-bearing capacity or resistance to certain media, e.g. acid, we recommend testing the application under actual or simulated conditions of use, as parameters such as exposure time, exposure quantity and temperature in particular have a major influence.