

ABL

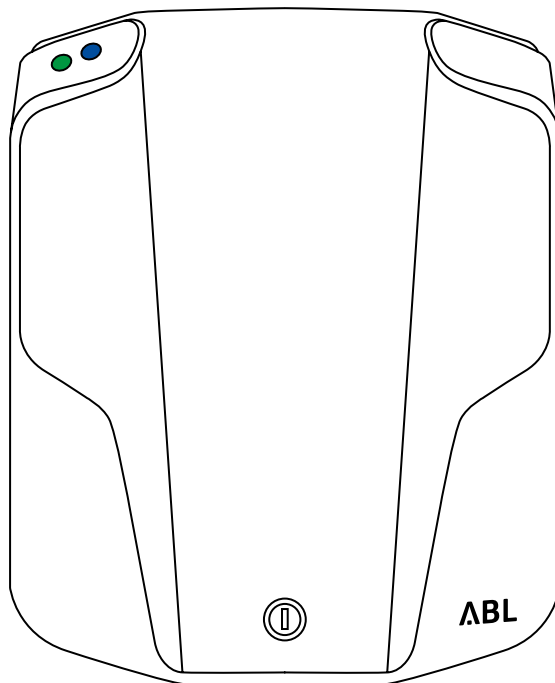

eMH1 Wallbox

Operating Manual

EN

**Congratulations
on your new eMH1 Wallbox!**

Your eMH1 is compact.
It's easy to use.
With a maximum of safety.

CONTENTS

Safety first

- | | |
|--------------------------------|----------|
| 1. Safety and user information | 5 |
|--------------------------------|----------|
-

Introduction

- | | |
|------------------------|-----------|
| 2. Your model variant | 14 |
| 3. Components included | 18 |
| 4. Accessories | 19 |
-

Charging procedure

- | | |
|-------------|-----------|
| 5. Charging | 24 |
|-------------|-----------|
-

Resolving errors

- | | |
|-------------------|-----------|
| 6. Error messages | 39 |
| 7. Display window | 50 |
| 8. Shutdown | 54 |
-

Appendix

- | | |
|--|-----------|
| 9. Definitions | 59 |
| 10. Technical specifications | 60 |
| 11. Standards, guidelines and trademarks | 65 |
| 12. Warranties and guarantees | 68 |
| 13. Disposal advice | 70 |

SAFETY FIRST

1. Safety and user information

5

1. SAFETY AND USER INFORMATION

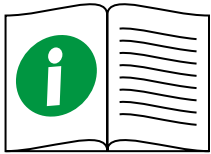

- Please observe all safety and user information
- Relevant local regulations for operating electrical devices always apply.



Indicates

- Dangerous electrical currents
- Dangers to life and limb



Indicates

- Risks arising from damage to the device
- Risks for other users



Indicates

- Important information and particularities

1. SAFETY AND USER INFORMATION

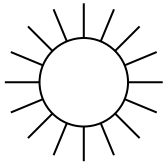

The Wallbox must not be exposed to direct sunlight



The installation site must offer protection against rain and running water or other liquids

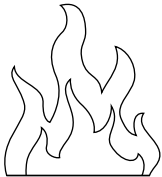

The Wallbox is not situated near a heat source

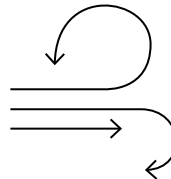

The installation site must offer sufficient air circulation.
Operating temperature:
p. 60

1. SAFETY AND USER INFORMATION

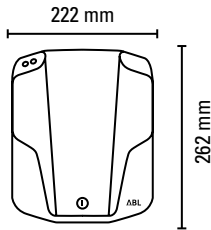

- The installation surface measures at least 262 x 222 mm (height x width)

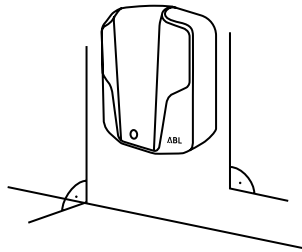

- The mounting substrate must be level and firm

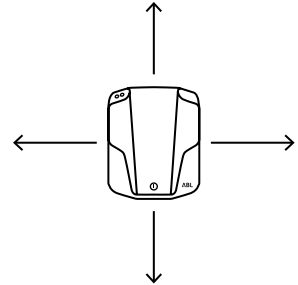

- Minimum distances to other technical installations must be observed

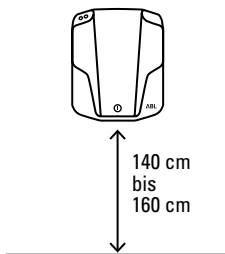

- The installation height is between 140 and 160 cm (floor to bottom edge of housing)

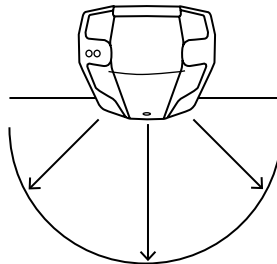

- The installation site must be freely accessible

1. SAFETY AND USER INFORMATION

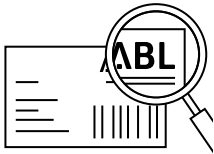

- The rated voltage must be observed.
Rated voltage: p. 60

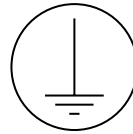

- The Wallbox must be connected to a protective earth conductor

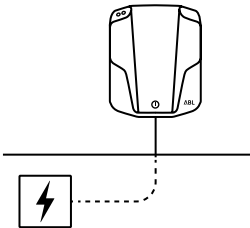

- Ideally, the installation site should already provide for connection to the electricity grid
- Otherwise, a power supply cable must be installed especially
- If unsure, please contact your specialist electrical contractor

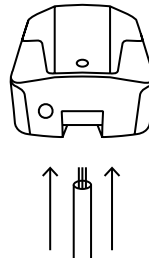

- Ideally, cable entry is from the underside of the housing base
- Above or below surface power supply possible

1. SAFETY AND USER INFORMATION

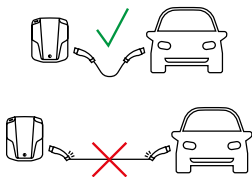

- The charging cable must not be under strain during the charging procedure

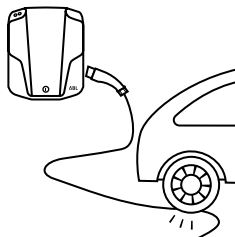

- The charging cable and the charging connector must not be driven over

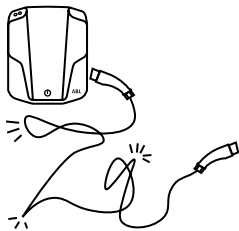

- The charging cable must not be kinked or twisted

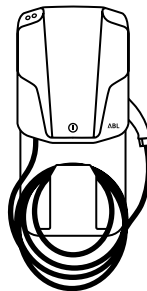

- The charging cable must be coiled tightly and stored. Accessories: p. 19

1. SAFETY AND USER INFORMATION



- (De-)installation and repairs must only be carried out by a specialist electrical contractor
- No modifications must be made to the Wallbox
- None of the components need to be maintained by the user

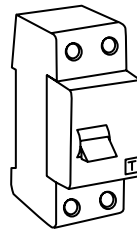

- The Wallbox must be protected by a Type A RCCB.
- Depending on the model variant, it may already be incorporated into the eMH1 Wallbox, or it must be installed upstream by the specialist electrical contractor

1. SAFETY AND USER INFORMATION

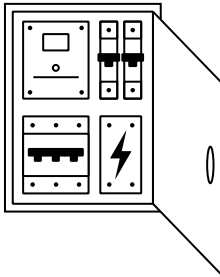

- The power supply in your domestic power distribution box must be protected separately by a suitable and accurately dimensioned miniature circuit breaker (C characteristic)

The eMH1 Wallbox

- Complies with all technical safety requirements, standards and guidelines. Standards & guidelines: p. 64
- Represents the current state of technology

- From October 2018, all eMH1 Wallbox model variants are equipped with an RCM14
- DC fault current detection is required by law in many countries
- The RCM14 means there is no need for a Type B RCCB

1. SAFETY AND USER INFORMATION

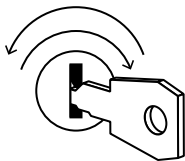

- The housing cover of the Wallbox must be locked

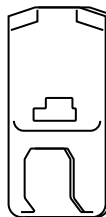

- Only accessories intended for the Wallbox and supplied by the manufacturer must be used.
Accessories: p. 19

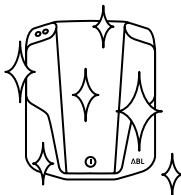

- The Wallbox must only be cleaned using a dry cloth
- No pressure cleaners or similar devices must be used

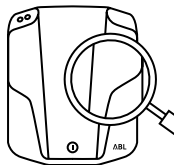

- The Wallbox must be checked regularly for its technically sound condition
- The 'T' button of the RCCB must be tripped once every 6 months. See the operating manual available at www.abl.de
- In case of damage, contact your local distributor first

INTRODUCTION

2. Your model variant	14
<hr/>	
3. Components included	18
<hr/>	
4. Accessories	19

2. YOUR MODEL VARIANT

Type plate
Model variants

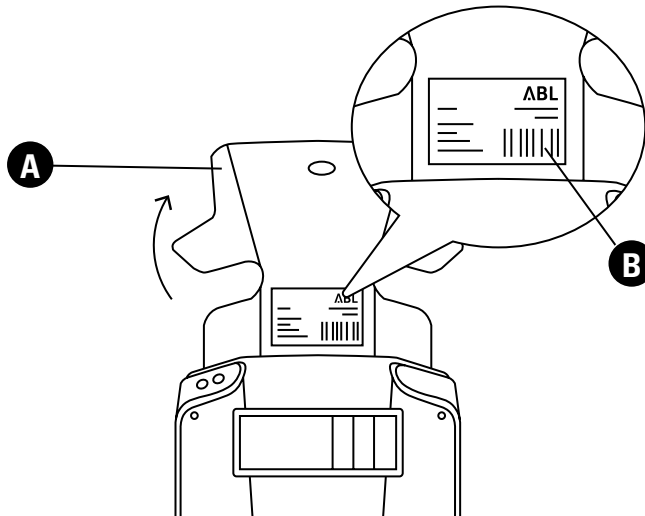

1 Open the cover

A Cover

2 The type plate is located
under the cover

B Type plate

3 p. 15

2. YOUR MODEL VARIANT

Type plate
Model variants



A Model number

B Power supply (voltage, frequency, current)

C IP rating

D Standard

E Standard

F Country of manufacture

G Manufacturer

H Manufacturer's logo

I Disposal notice

J 'Read instructions' advice

K CE label

L Barcode

M Serial Number

N Date printed

3 You can find your model variant on p. 60 using the data shown at **A** and **B**

2. YOUR MODEL VARIANT

Type plate
Model variants

TYPE 1 CHARGING CABLE

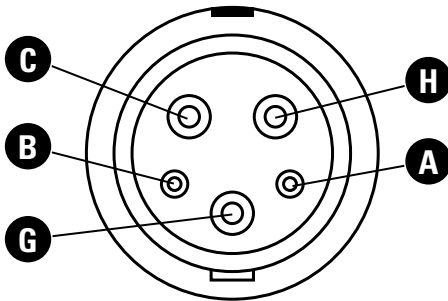

TYPE 2 CHARGING CABLE

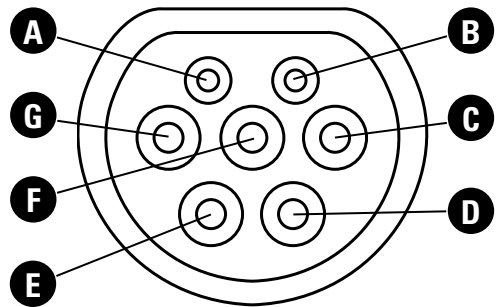

- A** CP – Control Pilot signaling contact
- B** PP – Proximity Pilot signaling contact
- C** L1 – Current-carrying conductor
- D** L2 – Current-carrying conductor

- E** L3 – Current-carrying conductor
- F** N – Neutral conductor
- G** PE – Protective Earth conductor
- H** L2 – Current-carrying conductor / N – Neutral conductor



- The eMH1 Wallbox with charging cable is equipped with a fixed charging cable with a Type 1 or Type 2 charging connector
- The charging cable is locked in the vehicle's charging socket
- No voltage will be applied to the charging cable via the current-carrying contacts unless it is locked into place

2. YOUR MODEL VARIANT

Type plate
Model variants

TYPE 2 CHARGING SOCKET

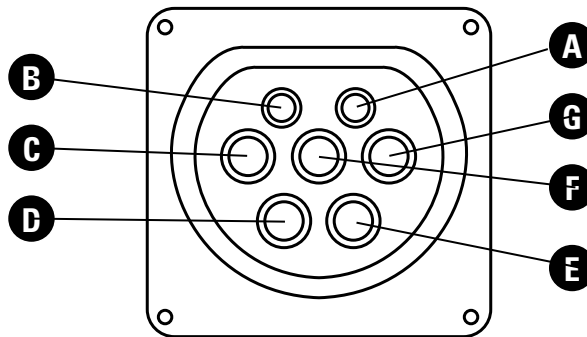

- A** CP – Control Pilot signaling contact
- B** PP – Proximity Pilot signaling contact
- C** L1 – Current-carrying conductor
- D** L2 – Current-carrying conductor
- E** L3 – Current-carrying conductor
- F** N – Neutral conductor
- G** PE – Protective Earth conductor



- The eMH1 Wallbox with charging socket is equipped with an integrated charging socket according to IEC 62196-2 Type 2
- The charging socket electromotively locks the charging cable as soon as the charging cable is connected to both the Wallbox and the vehicle
- No voltage will be applied to the charging cable via the current-carrying contacts of the socket unless it is locked into place
- ABL offers suitable charging cables as accessories.

Accessories: p. 19

3. COMPONENTS INCLUDED

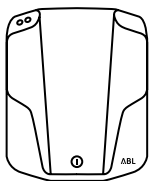

eMH1 Wallbox

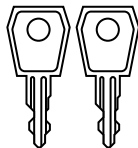

2 x keys

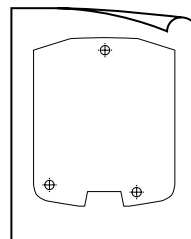

Drilling template

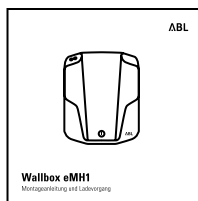

Installation manual

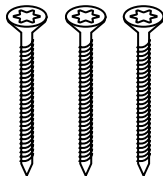

3 x screws (countersunk,
5 x 60 mm, T20)

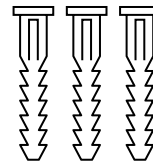

3 x wall plugs
(8 x 40 mm)

- 1 Check immediately after unpacking whether all components are included
- 2 In case of missing components, please contact your local distributor

4. ACCESSORIES



Mounting pole*

Powder-coated metal mounting pole with LED lighting, suitable for all eMH1 Wallboxes with or without mounting plate
h = 1650, w = 285, d = 150

*Wallbox not included

Foundation block for eMH1 mounting pole

For ground installation of the mounting pole, ABL offers a precast foundation block, which provides the necessary stability and security for the pole and has an integrated tube to protect the power supply. The foundation block is made from grade C 25/30 concrete and complies with exposure classes XC4 and XF1. 4 x M12 V2A mounting screws are included.

4. ACCESSORIES



Mounting plate

for all eMH1 Wallboxes

USB/RS485 Converter

To select charging currents via a serial RS485 interface on the EVCC
Virtual COM-Port
USB: Type B
RS485: RJ12 and MOLEX 5557
incl. software and two supply cables

4. ACCESSORIES



homeCLU

A future-oriented solution for the efficient and safe distribution of the existing domestic power supply.

Suitable for load management with all eMH1 Wallboxes incl. control unit, phase current measurement, power adapter and RS485-USB-adapter cable

Further information available at www.abl.de



4. ACCESSORIES



Type 2 charging cable

acc. to IEC 62196-2 · 32 A 240 /415 V AC · 3-phase
Length ca. 4 m IP44 splash protection rating



Type 2

Type 2 charging cable

acc. to IEC 62196-2 · 20 A 240 /415 V AC · 3-phase
Length ca. 7m IP44 splash protection rating



Type 2

Type 2 to Type 1 adapter cable

32 A 230 V AC · length ca. 4 m · single phase
splash proof (IP44)



Type 2



Type 1

CHARGING PROCEDURE

13. Charging

24



13. CHARGING

Before the charging procedure

During the charging procedure

After the charging procedure

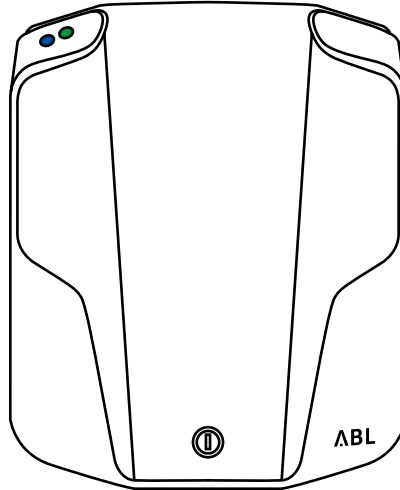

LED operating states



On



Flashing



Off



On



Flashing



Off

13. CHARGING

Before the charging procedure

During the charging procedure

After the charging procedure

Sequence A

The Wallbox is ready for use

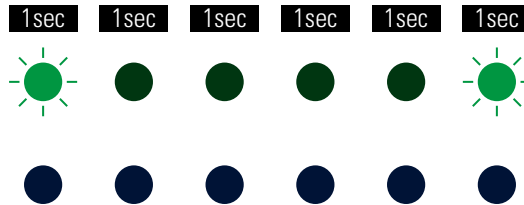

The green LED flashes every 5 seconds.

The blue LED is continuously Off

- 1 Check that the LED indicators of the Wallbox display this operating state. The vehicle may now be connected



Error messages are also displayed via the LEDs: p. 38

13. CHARGING

Before the charging procedure

During the charging procedure

After the charging procedure

TYPE 1 CHARGING CABLE

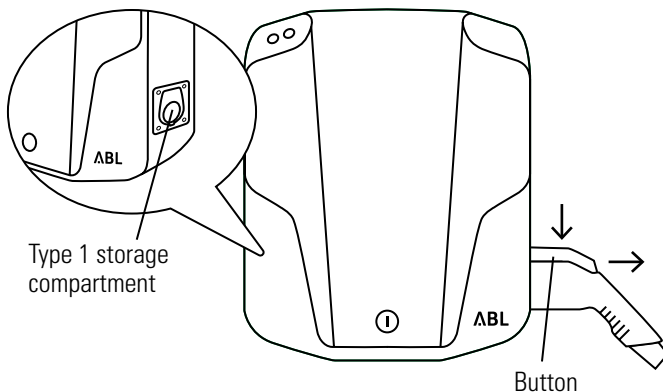

1 Keep the button on the Type 1 charging connector pressed down. The button is located on the top of the Type 1 charging connector

2 Pull the Type 1 charging connector from the Type 1 storage compartment

3 p. 29

4 p. 29

13. CHARGING

Before the charging procedure

During the charging procedure

After the charging procedure

TYPE 2 CHARGING CABLE

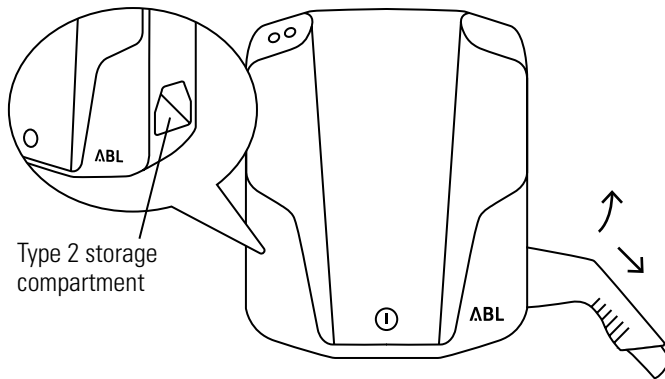

1 Gently lift the Type 2 charging connector from its storage compartment

2 Pull the Type 2 charging connector down to remove it from the Type 2 storage compartment

3 p. 29

4 p. 29

13. CHARGING

Before the charging procedure

During the charging procedure

After the charging procedure

TYPE 2 CHARGING SOCKET

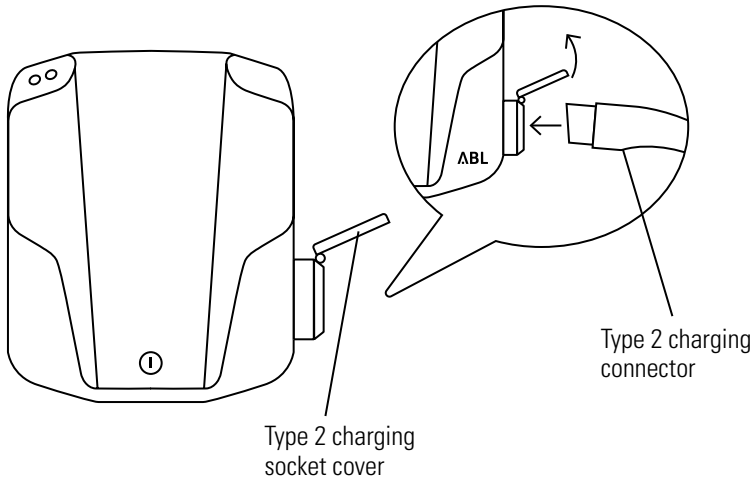

1 Open the cover of the Type 2 charging socket

2 Plug the Type 2 charging connector into the Type 2 charging socket

3 p. 29

4 p. 29

13. CHARGING

Before the charging procedure

During the charging procedure

After the charging procedure

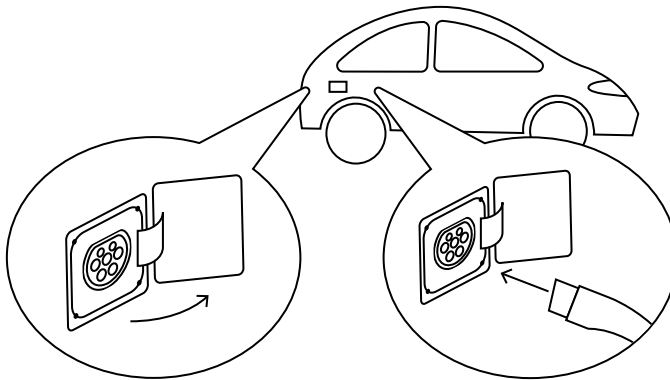

3 Open the vehicle's charging socket

4 Plug the charging connector into the vehicle's charging socket

13. CHARGING

Before the charging procedure
During the charging procedure
After the charging procedure

Sequence B1

The Wallbox is waiting for the vehicle to initiate the charging procedure

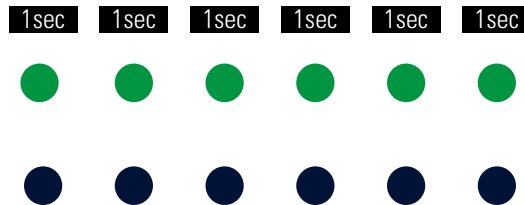

The green LED is continuously On
The blue LED is continuously Off

1 Check that the LED indicators of the Wallbox display this operating state. The charging procedure will start automatically as soon as the vehicle has been recognised

2 p. 31
3 p. 32



The charging procedure will only start when

- the vehicle has been connected
- the vehicle's charging timer is activated

13. CHARGING

Before the charging procedure
During the charging procedure
After the charging procedure

Sequence C2

The Wallbox is charging

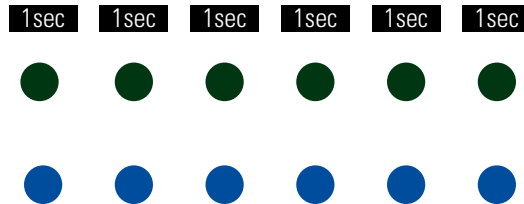

The green LED is continuously On
The blue LED is continuously Off

- 2 Check that the LED indicators of the Wallbox display this operating state. The charging procedure will start automatically as soon as the vehicle has been recognised

13. CHARGING

Before the charging procedure
During the charging procedure
After the charging procedure

Sequence B2

The charging procedure has been interrupted or completed

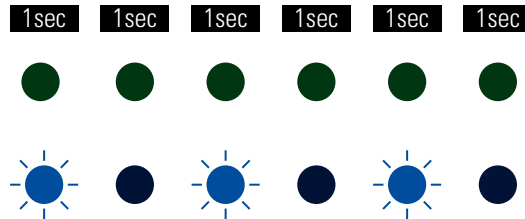

The green LED is continuously Off
The blue LED flashes every 2 seconds.

- 3 Check that the LED indicators of the Wallbox display this operating state. The charging procedure can be interrupted manually at the vehicle. The charging procedure is automatically terminated by the vehicle when the charging procedure has been completed

13. CHARGING

Before the charging procedure
During the charging procedure
After the charging procedure

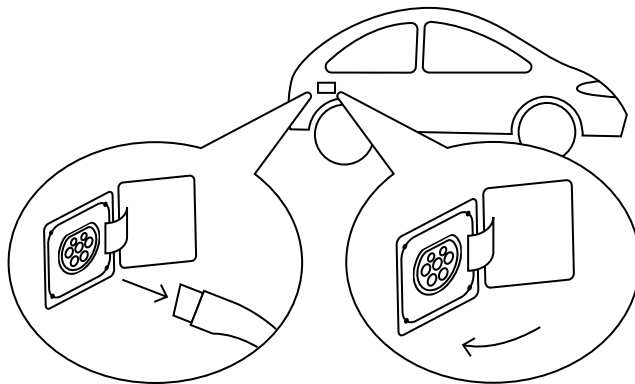

1 Pull the charging connector from the vehicle's socket.

2 Close the vehicle's charging socket

3-5 Type 1 charging cable: p. 34
Type 2 charging cable: p. 35
Type 2 charging socket: p. 36

6 p. 37

13. CHARGING

Before the charging procedure

During the charging procedure

After the charging procedure

TYPE 1 CHARGING CABLE

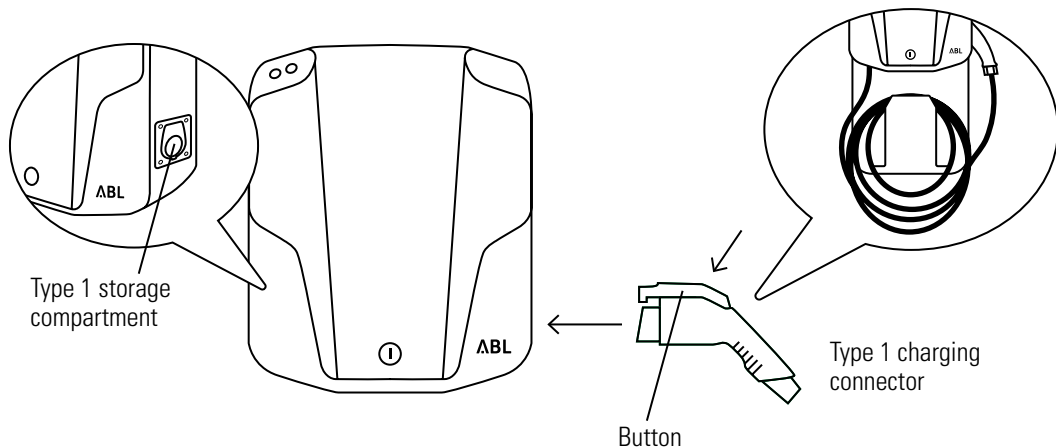

3 Keep the button on the Type 1 charging connector pressed down. The button is located on the top of the Type 1 charging connector

4 Insert the Type 1 charging connector into the Type 1 storage compartment

5 Coil the charging cable up tightly and store it, ready for the next charging procedure

6 p. 37



After the charging procedure, the charging connector must not

- be exposed
- remain plugged into the vehicle

13. CHARGING

Before the charging procedure
During the charging procedure
After the charging procedure

TYPE 2 CHARGING CABLE

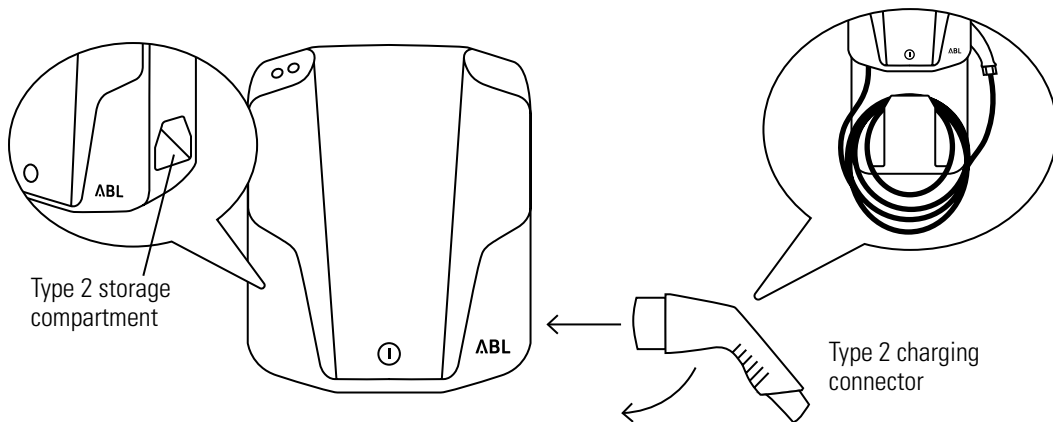

3 Slowly plug the Type 2 charging connector into the Type 2 storage compartment

4 Gently lower the Type 2 charging connector

5 Coil the charging cable up tightly and store it, ready for the next charging procedure

6 p. 37



After the charging procedure, the charging connector must not

- be exposed
- remain plugged into the vehicle

13. CHARGING

Before the charging procedure
During the charging procedure
After the charging procedure

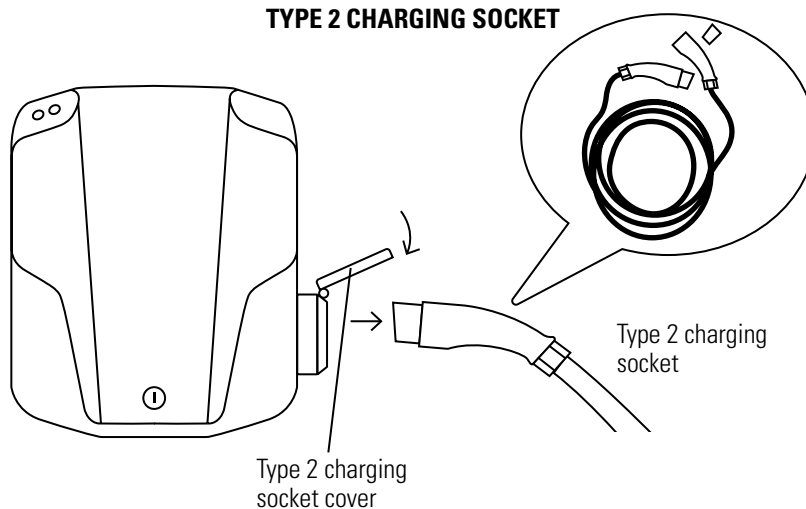

- 3** Pull the Type 2 charging connector from the Type 2 charging socket
- 4** Close the cover of the Type 2 charging socket

- 5** Coil the charging cable up tightly and store it, ready for the next charging procedure

6 p. 37



After the charging procedure, the charging connector must not

- be exposed
- remain plugged into the vehicle

13. CHARGING

Before the charging procedure
During the charging procedure
After the charging procedure

Sequence A

The Wallbox is ready for use

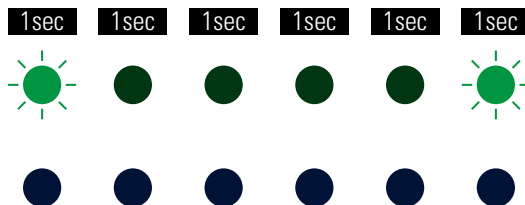

The green LED flashes every 5 seconds.
The blue LED is continuously Off

6 Check that the LED indicators of the Wallbox display this operating state. The vehicle may now be connected



- The actual charging time depends on
 - The type of battery fitted to your vehicle
 - The charge currently remaining in the battery
- It is therefore not possible to make a firm prediction of the charging time

RESOLVING ERRORS

6. Error messages	39
7. Display window	50
8. Shutdown	54

6. ERROR MESSAGES

LED presets

Only green LEDs

Only blue LEDs

Both LEDs

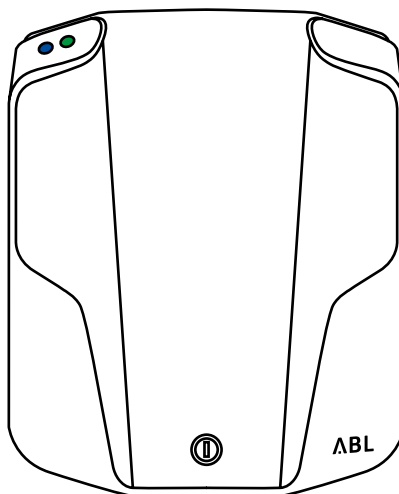

LED operating states



On



Flashing



Off



On



Flashing



Off

6. ERROR MESSAGES

LED presets
Only green LEDs
Only blue LEDs
Both LEDs

Sequence F1

The main contactor of the Wallbox does not open

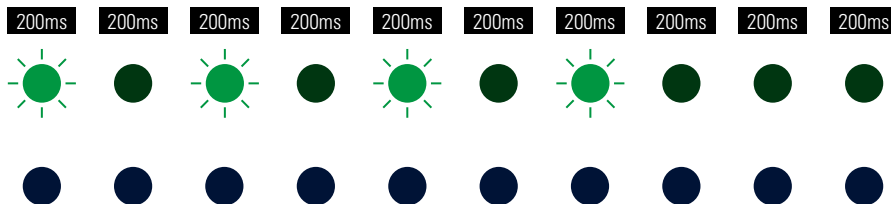

The green LED flashes four times
The blue LED is continuously Off

- 1 Switch the power supply off and then back on again
- 2 If the error continues to occur, take the Wallbox out of operation permanently. Shutdown: p. 54

Contact your specialist electrical contractor to have the error resolved

6. ERROR MESSAGES

LED presets
Only green LEDs
Only blue LEDs
Both LEDs

Sequence F8

The Wallbox has detected a short circuit between the Pilot Contact CP and the Protective Earth conductor PE

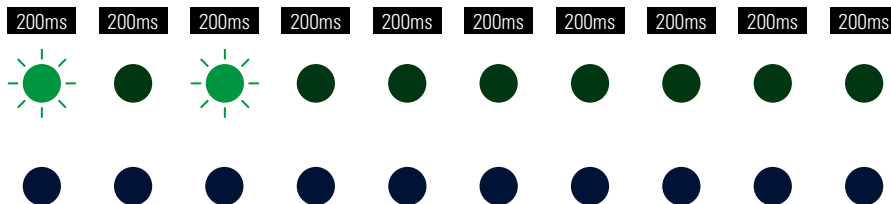

The green LED flashes twice
The blue LED is continuously Off

- 1** The Wallbox automatically reinitiates the charging procedure every 60 seconds
- 2** If the error continues to occur, take the Wallbox out of operation permanently. Shutdown: p. 54
- 3** If no fault could be detected with the charging cable, check the vehicle. Contact a qualified specialist repairer for this purpose

Contact your specialist electrical contractor to check the charging cable and the Wallbox for correct functioning

6. ERROR MESSAGES

LED presets
Only green LEDs
Only blue LEDs
Both LEDs

Sequence F5

- A** The charging cable is not properly plugged in
B The internal control pilot switch is set to the 0 position

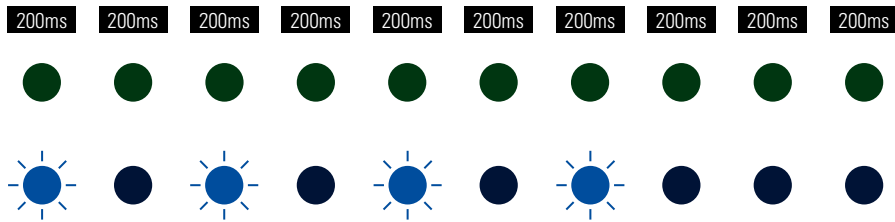

The green LED is continuously Off
The blue LED flashes four times.

- A**
- 1 Remove the charging connector from the vehicle
 - 2 Plug the charging connector back into the vehicle
 - 3 Ensure that the charging connector sits correctly in the vehicle socket
- B**
- 1 Open the housing cover
 - 2 Return the CP switch to the I position



- In principle, the charging procedure is always terminated by the electric vehicle, not by the Wallbox
- The Wallbox indicates that the charging cable can be removed from the vehicle's charging socket

6. ERROR MESSAGES

LED presets
Only green LEDs
Only blue LEDs
Both LEDs

Sequence F2

The firmware has detected a disallowed operating state during the initial or a periodic self-test

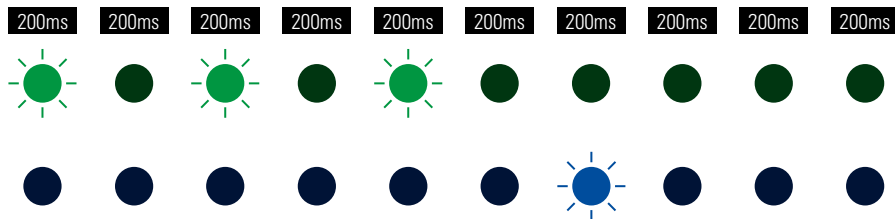

The green LED flashes three times.
Then the blue LED flashes once

- 1 Switch the power supply off and then back on again
- 2 If the error continues to occur, take the Wallbox out of operation permanently. Shutdown: p. 54

Contact your specialist electrical contractor to have the error resolved

6. ERROR MESSAGES

LED presets
Only green LEDs
Only blue LEDs
Both LEDs

Sequence F3

The automatic self-test of the internal RCM14 has returned an error, or a DC fault current has been detected in connection with the vehicle

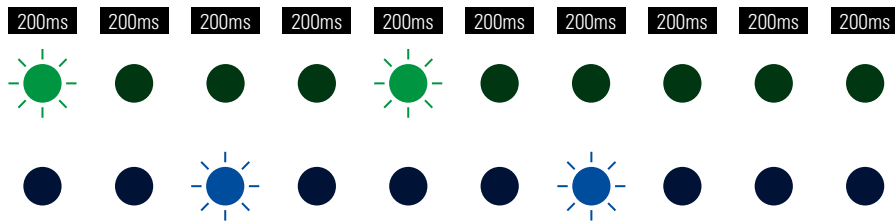

The green and blue LEDs alternately flash twice each

- 1 If the error is occurring for the first time, the charging procedure is interrupted for 30 seconds and then restarted automatically. The charging procedure is cancelled. A new charging procedure is only possible after disconnecting the vehicle from the Wallbox.
- 2 Take the Wallbox out of operation permanently.
Shutdown: p. 54
Check the vehicle for electrical faults in the charging system. Contact a qualified specialist repairer for this purpose.



- When error messages are displayed continuously,
 - take the Wallbox out of operation permanently.
Shutdown: p. 54
 - Contact the specialist electrical contractor
- Should the problem persist, please contact ABL technical support.
Technical support: p. 70

6. ERROR MESSAGES

LED presets
Only green LEDs
Only blue LEDs
Both LEDs

Sequence F4

Communication with the RFID failed

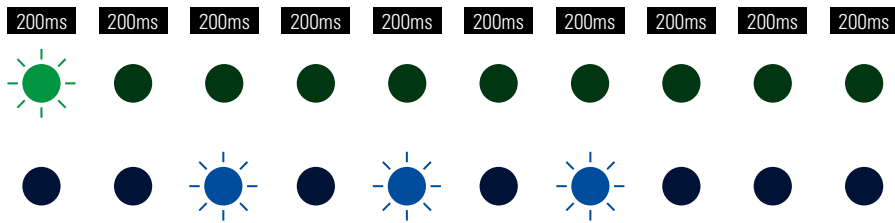

The green LED flashes once
Then the blue LED flashes three times

- 1 Switch the power supply off and then back on again
- 2 If the error continues to occur, take the Wallbox out of operation permanently. Shutdown: p. 54

Contact your specialist electrical contractor to have the error resolved

6. ERROR MESSAGES

LED presets
Only green LEDs
Only blue LEDs
Both LEDs

Sequence F6

The charging cable is faulty

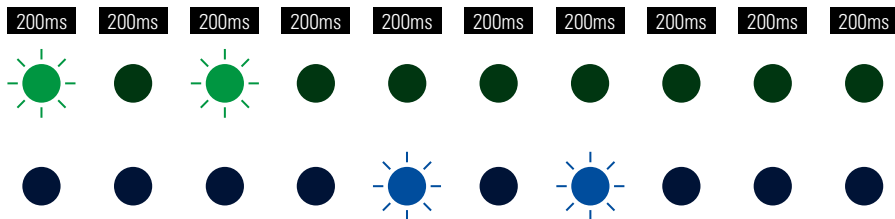

The green LED flashes twice
Then the blue LED flashes twice

- 1 Switch the power supply off and then back on again
- 2 If the error continues to occur, take the Wallbox out of operation permanently. Shutdown: p. 54

Contact your specialist electrical contractor to have the error resolved

6. ERROR MESSAGES

LED presets
Only green LEDs
Only blue LEDs
Both LEDs

Sequence F9

An overcurrent has been detected

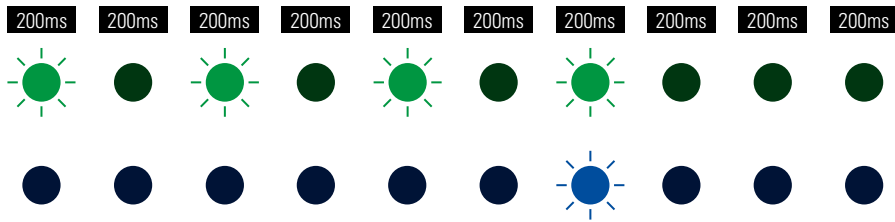

The green LED flashes four times
The blue LED flashes every fourth time

- 1 Switch the power supply off and then back on again
- 2 If the error continues to occur, take the Wallbox out of operation permanently. Shutdown: p. 54
- 3 If the error continues to occur, check the vehicle. Contact a qualified specialist repairer for this purpose

Contact your specialist electrical contractor to have the error resolved

6. ERROR MESSAGES

LED presets
Only green LEDs
Only blue LEDs
Both LEDs

Sequence F10

The temperature monitor has detected a temperature above 80° Celsius inside the housing

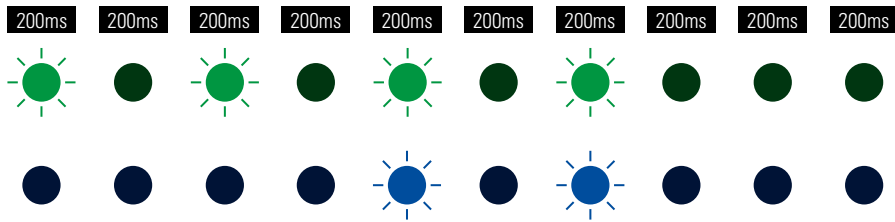

The green LED flashes four times
The blue LED flashes every third and fourth time

- 1 The temperature monitor interrupts the charging procedure. After 10 minutes, the charging procedure is reinitiated automatically
- 2 Error code F8 is shown if the temperature inside the housing remains at between 60° and 80° Celsius, F8: p. 41
- 3 The charging procedure is reinitiated as soon as the temperature inside the housing has fallen to below 60° Celsius
- 4 Ensure better cooling and/or shading of the Wall-box. Should the error recur or persist, contact the specialist electrical contractor to resolve the error. Operating temperature: p. 60

6. ERROR MESSAGES

LED presets
Only green LEDs
Only blue LEDs
Both LEDs

Sequence F11

The main contactor does not close

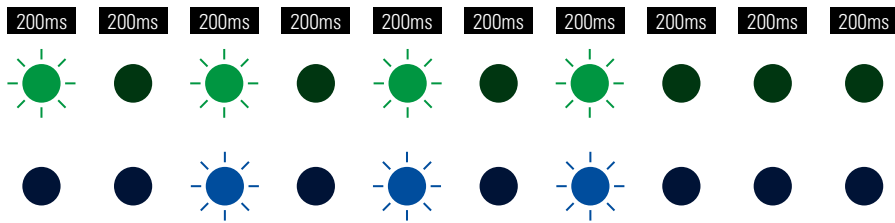

The green LED flashes once
Then the green and blue LEDs alternately flash three times each

1 The Wallbox automatically re-initiates the charging procedure after 60 seconds and repeats this process for 10 minutes

2 If the error continues to occur, take the Wallbox out of operation permanently. Shutdown: p. 54

Contact your specialist electrical contractor to have the error resolved

7. DISPLAY WINDOW

Energy consumption

Circuit breaker

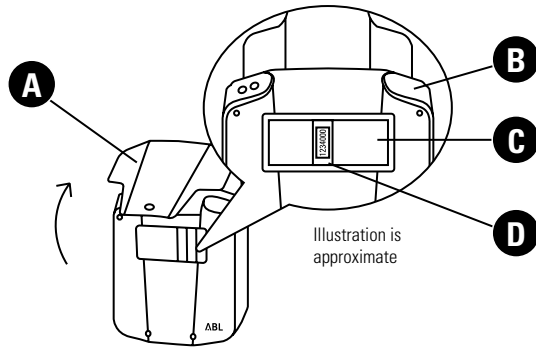

1 Open the cover

A Cover

2 Locate the power meter in the central display window. The display window is located in the upper part of the housing

B Upper part of housing

C Display window

D Power meter

3 p. 51

4 p. 51

7. DISPLAY WINDOW

Energy consumption

Circuit breaker

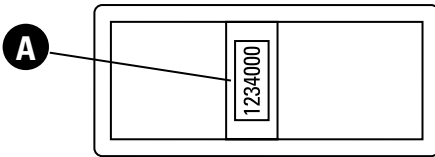
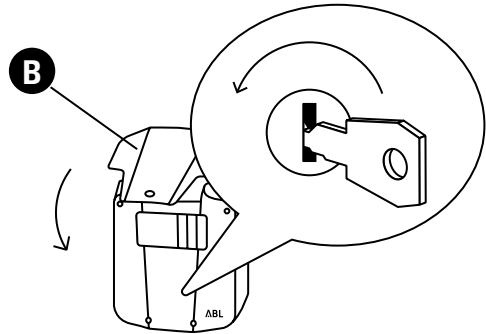

Illustration is approximate



3 Read the energy consumption shown by the digital display

A Digital display

4 Close the cover

Tool:

Key

B Cover

7. DISPLAY WINDOW

Energy consumption
Circuit breaker

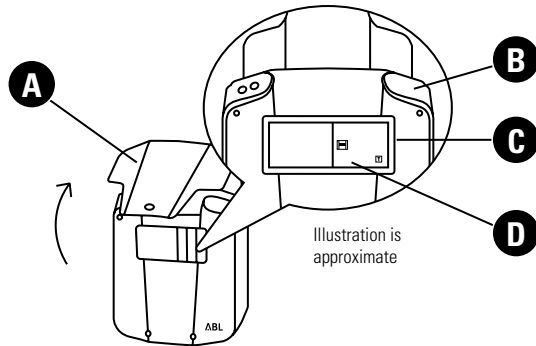

1 Open the cover

A Cover

B Upper part of housing

C Display window

D RCCB

2 Locate the RCCB in the central display window. The display window is located in the upper part of the housing

3-7 p. 53



- From October 2018, all eMH1 Wallbox model variants are equipped with an RCM14
- The RCM14 conducts a self-test before each charging procedure
- If the test returns an error, the LEDs will show the respective error sequence. Error messages: p. 39

7. DISPLAY WINDOW

Energy consumption
Circuit breaker

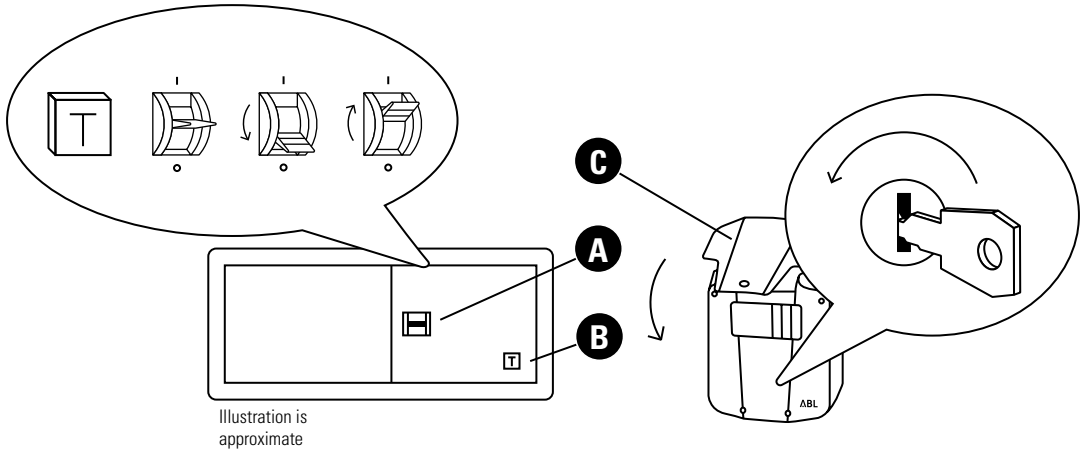

3 Press the 'T' button on the RCCB

4 The RCCB trips and flick its pivot lever into the center position

5 Flick the pivot lever to the 0 position

6 Flick the pivot lever to the I position

7 Close the cover
Tool: Key

A Pivot lever

B 'T' button

C Cover



- The RCCB's 'T' button
 - checks the correct functioning of the Wallbox
 - must be tested every six months

- If the 'T' button does not trip,
 - take the Wallbox out of operation permanently.
Shutdown: p. 54
 - Contact your local distributor

8. SHUTDOWN

Temporary
Permanent

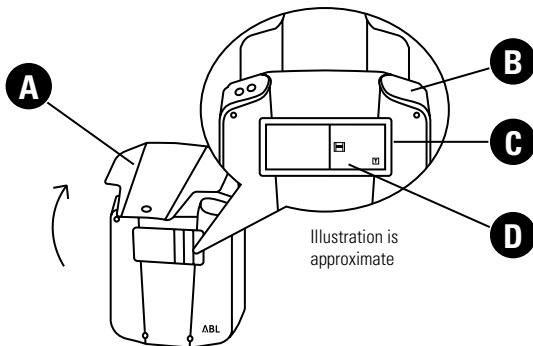

1 Open the cover

A Cover

B Upper part of housing

C Display window

D RCCB

2 Locate the RCCB in the central display window. The display window is located in the upper part of the housing

3-4 p. 55

8. SHUTDOWN

Temporary
Permanent

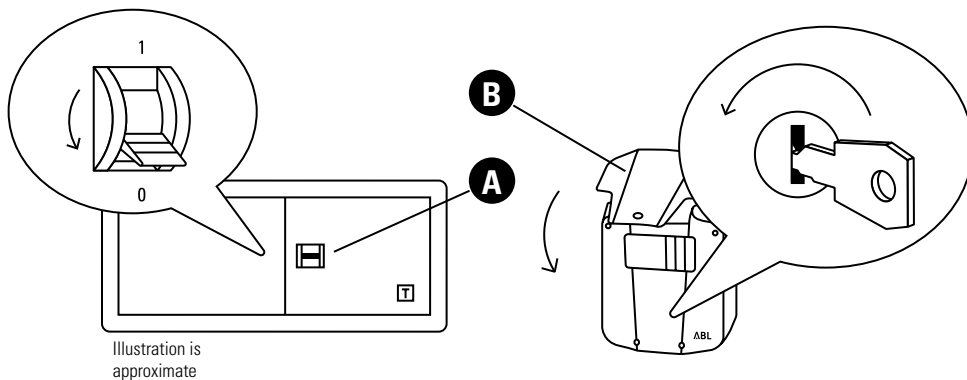

3 Flick the pivot lever of the internal RCCB to the 0 position. Connection to the electricity grid is now interrupted. The Wallbox can no longer carry out charging procedures

4 Close the cover

Tool:
Key



In the absence of an RCCB, the circuit breaker in the domestic power distribution must be switched off in order to take the Wallbox out of operation temporarily or permanently

A Pivot lever

B Cover

8. SHUTDOWN

Temporary
Permanent

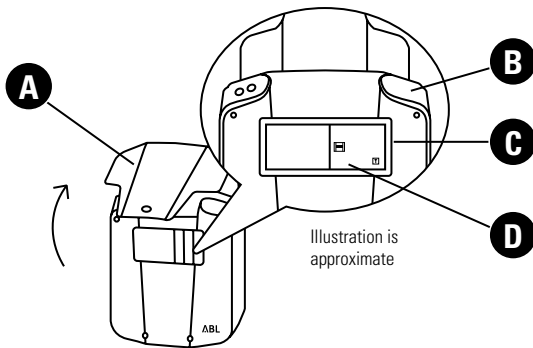

1 Open the cover

A Cover

B Upper part of housing

C Display window

D RCCB

2 Locate the RCCB in the central display window. The display window is located in the upper part of the housing

3-5 p. 57



The electrical de-installation of the Wallbox must always be carried out by a qualified specialist electrical contractor

8. SHUTDOWN

Temporary
Permanent

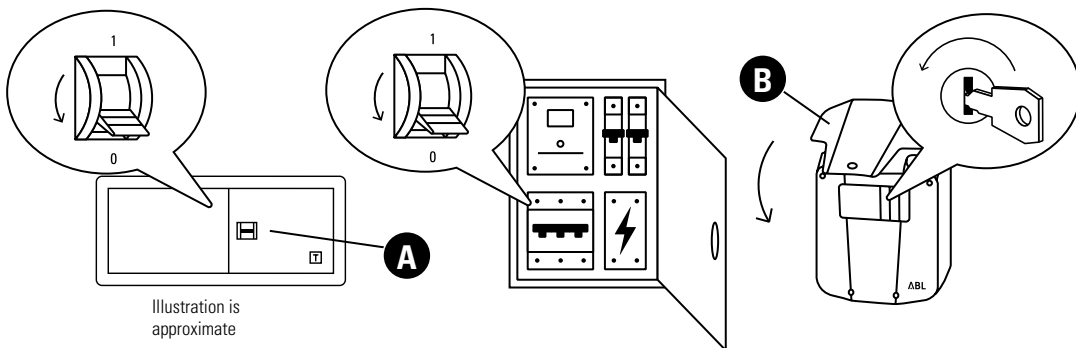

3 Flick the pivot lever to the 0 position. Connection to the electricity grid is now interrupted. The Wallbox can no longer carry out charging procedures

4 Switch off the circuit breaker in the domestic power distribution

5 Close the cover

Tool:
Key

B Cover

A Pivot lever

APPENDIX

9. Definitions	59
10. Technical specifications	60
11. Standards, guidelines and trademarks	65
12. Warranties and guarantees	68
13. Disposal advice	70

9. DEFINITIONS

ABBREVIATION	EXPLANATION
DC	Direct Current
eMH1	Electric Mobility Home
EVCC	Electric Vehicle Charge Control
RCBO	Residual current operated Circuit Breaker with Overcurrent protection
RCCB	Residual Current Circuit Breaker
LED	Light Emitting Diode
RCM	Residual Current Monitor
RFID	Radio Frequency Identification
'T'-button	Testing button

10. TECHNICAL SPECIFICATIONS

Model code 11kW	1W1121 1W11K2 1W11N2	1W1101 1W11K1 1W11N1
Rated voltage	230/400 V	230/400 V
Grid frequency	50 Hz	50 Hz
Current	16 A	16 A
Charging output	11 kW	11 kW
Charging connection	Type 2 charging socket	Type 2 charging cable (ca. 6m)
Phase system	3-phase	3-phase
Residual-Current Devices	RCCB, Type A, 30 mA	RCCB, Type A, 30 mA
DC fault current detection	DC-RCM, $I_{\Delta n}$ d.c. ≥ 6 mA	DC-RCM, $I_{\Delta n}$ d.c. ≥ 6 mA
EVCC	2	2
Compliance	IEC 61851-1	IEC 61851-1
Control / Customization	Internal RS485 interface	Internal RS485 interface
Terminal block	up to 50 mm ²	up to 50 mm ²
Operating temperature	-30°C to 50°C	-30°C to 50°C
Storage temperature	-30°C to 85°C	-30°C to 85°C
Rel. humidity	5 to 95% (no condensation)	5 to 95% (no condensation)
Class of protection	I	I
Degree of protection (housing)	IP44	IP54
Overvoltage category	III	III
Dimensions	272 x 221 x 116 mm (H x W x D)	272 x 221 x 116 mm (H x W x D)
Weight per unit	ca. 3 kg	ca. 4.5 kg

10. TECHNICAL SPECIFICATIONS

Model code 3.6 kW	1W36P1
Voltage	230 V
Grid frequency	50 Hz
Current	16 A
Charging output	3.6 kW
Charging connection	Type 2 charging cable (ca. 6m)
Phase system	1-phase
Residual-Current Devices	RCCB, Type A, 30 mA
DC fault current detection	DC-RCM, $I_{\Delta n}$ d.c. ≥ 6 mA
EVCC	2
Compliance	IEC 61851-1
Control / Customization	Internal RS485 interface
Terminal block	up to 50 mm ²
Operating temperature	-30°C to 50°C
Storage temperature	-30°C to 85°C
Rel. humidity	5 to 95% (no condensation)
Class of protection	I
Degree of protection (housing)	IP54
Overvoltage category	III
Dimensions	272 x 221 x 116 mm (H x W x D)
Weight per unit	ca. 4.5 kg

10. TECHNICAL SPECIFICATIONS

Model code 7.2 kW	1W7221 1W72P2	1W7201 1W72P1	1W7241
Voltage	230 V	230 V	230 V
Grid frequency	50 Hz	50 Hz	50 Hz
Current	32 A	32 A	32 A
Charging output	7.2 kW	7.2 kW	7.2 kW
Charging connection	Type 2 charging socket	Type 2 charging cable (ca. 6m)	Type 2 charging cable (ca. 5m)
Phase system	1-phase	1-phase	1-phase
Residual-Current Devices	RCCB, Type A, 30 mA	RCCB, Type A, 30 mA	RCCB, Type A, 30 mA
DC fault current detection	DC-RCM, $I_{\Delta n}$ d.c. ≥ 6 mA	DC-RCM, $I_{\Delta n}$ d.c. ≥ 6 mA	DC-RCM, $I_{\Delta n}$ d.c. ≥ 6 mA
EVCC	2	2	2
Compliance	IEC 61851-1	IEC 61851-1	IEC 61851-1
Control / Customization	Internal RS485 interface	Internal RS485 interface	Internal RS485 interface
Terminal block	up to 50 mm ²	up to 50 mm ²	up to 50 mm ²
Operating temperature	-30°C to 50°C	-30°C to 50°C	-30°C to 50°C
Storage temperature	-30°C to 85°C	-30°C to 85°C	-30°C to 85°C
Rel. humidity	5 to 95% (no condensation)	5 to 95% (no condensation)	5 to 95% (no condensation)
Class of protection	I	I	I
Degree of protection (housing)	IP44	IP54	IP54
Overvoltage category	III	III	III
Dimensions	272 x 221 x 116 mm (H x W x D)	272 x 221 x 116 mm (H x W x D)	272 x 221 x 116 mm (H x W x D)
Weight per unit	ca. 3 kg	ca. 4.5 kg	ca. 4 kg

10. TECHNICAL SPECIFICATIONS

Model code 22 kW	1W2221	1W2201
Voltage	230 / 400 V	230 / 400 V
Grid frequency	50 Hz	50 Hz
Current	32 A	32 A
Charging output	22 kW	22 kW
Charging connection	Type 2 charging socket	Type 2 charging cable (ca. 6m)
Phase system	3-phase	3-phase
Residual-Current Devices	RCCB, Type A, 30 mA	RCCB, Type A, 30 mA
DC fault current detection	DC-RCM, $I_{\Delta n}$ d.c. ≥ 6 mA	DC-RCM, $I_{\Delta n}$ d.c. ≥ 6 mA
EVCC	2	2
Compliance	IEC 61851-1	IEC 61851-1
Control / Customization	Internal RS485 interface	Internal RS485 interface
Terminal block	up to 50 mm ²	up to 50 mm ²
Operating temperature	-30°C to 50°C	-30°C to 50°C
Storage temperature	-30°C to 85°C	-30°C to 85°C
Rel. humidity	5 to 95% (no condensation)	5 to 95% (no condensation)
Class of protection	I	I
Degree of protection (housing)	IP44	IP54
Overvoltage category	III	III
Dimensions	272 x 221 x 116 mm (H x W x D)	272 x 221 x 116 mm (H x W x D)
Weight per unit	ca. 3 kg	ca. 4.5 kg

10. TECHNICAL SPECIFICATIONS

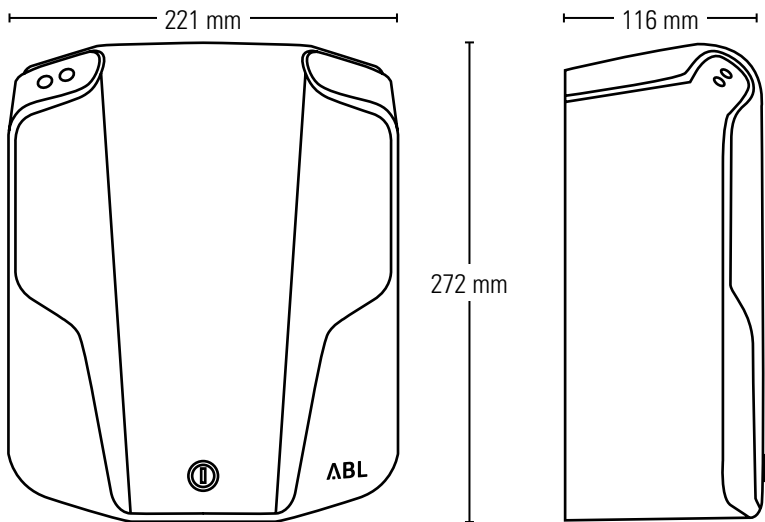

11. STANDARDS, GUIDELINES AND TRADEMARKS

GENERAL STANDARDS

2014/30/EU	EMC Directive
2011/65/EU	RoHS Directive
2012/19/EU	WEEE Directive
2014/35/EU	Low Voltage Directive

ELECTROMAGNETIC COMPATIBILITY STANDARDS (EMC)

IEC 61851-21-2	Conductive charging systems for electric vehicles - Part 21-2: EMC requirements for off-board electric vehicle charging systems
----------------	---

DEVICE SAFETY STANDARDS

IEC 61851-1 Ed. 3	Electrical equipment for electric road vehicles - conductive charging systems for electric vehicles – Part 1: General requirements
IEC 60364-7-722 Ed. 1	Low voltage installations – Part 7-722: requirements for operation in special operating sites, premises and installations – power supply for electric vehicles

11. STANDARDS, GUIDELINES AND TRADEMARKS

All trademarks mentioned in this manual including those that may be protected by third parties are, without restriction, subject to the regulations of the respectively applicable trademark law and the property rights of the respective registered owners. All trademarks, trading names or company names marked here as such are or may be trademarks or registered trademarks of their respective owners. All rights not explicitly granted here are reserved. The absence of an explicit marking of trademarks used in this manual must not lead to the conclusion that a name is free from the rights of third parties.

11. STANDARDS, GUIDELINES AND TRADEMARKS



CE certification and declaration of compliance

The Wallbox carries the CE mark. The respective compliance declarations can be obtained from ABL SURSUM Bayerische Elektrozubehör GmbH & Co. KG on request and are available at www.abl.de for download.

12. WARRANTY AND GUARANTEE PROVISIONS

ABL provides the legally prescribed guarantee period as well as a warranty of the same duration for the country in which the product was purchased. Should the product be operated in another country, the legal provisions of the country of purchase apply nevertheless: Under no circumstances are guarantees or the warranty transferable. Should modifications of any kind have been made to the product that have not been explicitly authorized by ABL or described in the guidelines for authorized service partners, the manufacturer's warranty obligations become void with immediate effect. On-site repairs are generally excluded by the manufacturer. In case of disregard of this provision, all guarantee and warranty provisions become void with immediate effect.



Should problems occur when operating your product, please contact your local distributor immediately and clarify whether the malfunction is covered by guarantee or warranty provisions. Do not under any circumstances make alterations or repairs to your product yourself!

12. WARRANTY AND GUARANTEE PROVISIONS

ABL guarantees the proper operation of the product after delivery within the applicable legal guarantee provisions. This guarantee is limited to damage that can be shown to have resulted from normal use and obvious material or manufacturing defects. In such cases the manufacturer, in collaboration with the local distributor, will attempt to restore the proper functioning of the product. The customer will be responsible for covering any arising transport costs. However, the manufacturer further rejects any damage claims that can be shown to have resulted from improper use, neglect or modifications, from repair attempts by unauthorized persons or force majeure.



Consider leaving the final installation to a qualified and authorized electrical contractor: Should malfunctions occur that can be shown to have resulted from improper mounting and installation, all guarantee and warranty provisions will become void. Proof of proper installation (e.g. by submitting the relevant invoices) must be furnished on request before guarantee and warranty provisions come into effect.

13. DISPOSAL ADVICE



The crossed out trash can symbol indicates that electrical and electronic devices including accessories must be disposed of separate from household trash. The materials are recyclable as marked. By re-using, recycling or through other forms of processing obsolete devices, you make an important contribution to environmental protection.



ABL ABL SURSUM
Bayerische Elektrozubehör
GmbH & Co. KG

Albert-Büttner-Straße 11 · D-91207 Lauf/Pegnitz
Tel. +49 (0)9123 188-0 · Fax +49 (0)9123 188-18
info@abl.de · www.abl.de